

ALIENWARE® M17x SERVICE MANUAL

Notes, Cautions, and Warnings



NOTE: A NOTE indicates important information that helps you make better use of your computer.



CAUTION: A CAUTION indicates either potential damage to hardware or loss of data and tells you how to avoid the problem.



WARNING: A WARNING indicates a potential for property damage, personal injury, or death.

The contents herein are subject to change without notice.

© 2009 Dell Inc. All rights reserved.

Reproduction of these materials in any manner whatsoever without the prior written permission of Dell Inc. is strictly prohibited.

Trademarks used in this manual: Alienware is a registered trademark of Alienware Corporation. Dell and the Dell Logo are trademarks of Dell Inc. Bluetooth is a registered trademark owned by Bluetooth SIG, Inc. and is used by Dell under license. Microsoft, Windows, Windows Vista, and Windows Vista start button logo are either trademarks or registered trademarks of Microsoft Corporation in the United States and/or other countries.

Other trademarks and trade names may be used in this manual to refer to either the entities claiming the marks and names or their products. Dell Inc. disclaims any proprietary interest in trademarks and trade names other than its own.

Rev. A00

MAY 2009

CONTENTS

CHAPTER 1: BEFORE YOU BEGIN 6

- Recommended Tools 7
- Turning Off Your Computer 7
- Before Working Inside Your Computer 8

CHAPTER 2: BATTERY PACK 9

- Removing the Battery Pack 11
- Replacing the Battery Pack 11

CHAPTER 3: COMPARTMENT DOOR 12

- Removing the Compartment Door 14
- Replacing the Compartment Door 14

CHAPTER 4: HARD DRIVE(S) 15

- Removing the Hard Drive(s) 17
- Replacing the Hard Drive(s) 19

CHAPTER 5: PROCESSOR THERMAL FAN 20

- Removing the Processor Thermal Fan 22
- Replacing the Processor Thermal Fan 22

CHAPTER 6: COIN-CELL BATTERY 23

- Removing the Coin-Cell Battery 25
- Replacing the Coin-Cell Battery 25

CHAPTER 7: MEMORY MODULE(S) 26

- Removing the Memory Module(s) 28
- Replacing the Memory Module(s) 29

CHAPTER 8: CENTER CONTROL COVER 31

- Removing the Center Control Cover 33
- Replacing the Center Control Cover 35

CHAPTER 9: KEYBOARD 36

- Removing the Keyboard 38
- Replacing the Keyboard 39

CHAPTER 10: PALM REST 40

- Removing the Palm Rest 42
- Replacing the Palm Rest 44

CHAPTER 11: BRACKETS	45	CHAPTER 16: WIRELESS MINI-CARD(S)	69
Removing the Brackets	47	Removing the Mini-Card(s)	71
Replacing the Brackets	47	Replacing the Mini-Card(s)	73
CHAPTER 12: MAGNESIUM COVER	48	CHAPTER 17: PROCESSOR HEAT SINK	74
Removing the Magnesium Cover	50	Removing the Processor Heat Sink	76
Replacing the Magnesium Cover	51	Replacing the Processor Heat Sink	77
CHAPTER 13: DISPLAY	52	CHAPTER 18: GRAPHICS CARD(S)	78
Removing the Display Assembly	53	Removing the Graphics Card(s)	80
Replacing the Display Assembly	55	Replacing the Graphics Card(s)	81
Removing the Display Back Cover	56	CHAPTER 19: GRAPHICS CARD FAN(S)	82
Replacing the Display Back Cover	58	Removing the Graphics Card Fan(s)	84
Removing the AlienHead Board	59	Replacing the Graphics Card Fan(s)	85
Replacing the AlienHead Board	60	CHAPTER 20: GRAPHICS CARD BLANK	86
CHAPTER 14: INPUT/OUTPUT BOARD	61	Removing the Graphics Card Blank	88
Removing the Input/Output Board	62	Replacing the Graphics Card Blank	88
Replacing the Input/Output Board	64	CHAPTER 21: SYSTEM BOARD	89
CHAPTER 15: OPTICAL DRIVE	65	Removing the System Board	90
Removing the Optical Drive	66	Replacing the System Board	92
Replacing the Optical Drive	68		

- CHAPTER 22: SPEAKERS..... 93**
 - Removing the Speakers 95
 - Replacing the Speakers..... 95

- CHAPTER 23: CONSUMER IR BOARD 96**
 - Removing the Consumer IR Board..... 98
 - Replacing the Consumer IR Board 98

- CHAPTER 24: BATTERY LATCH ASSEMBLY 99**
 - Removing the Battery Latch Assembly 101
 - Replacing the Battery Latch Assembly 101

- CHAPTER 25: FLASHING THE BIOS 102**
 - Flashing the BIOS from a CD 103
 - Flashing the BIOS from the Hard Drive..... 104



CHAPTER 1: BEFORE YOU BEGIN

This section provides procedures for removing and installing the components in your computer. Unless otherwise noted, each procedure assumes that the following conditions exist:

- You have performed the steps in “Turning Off Your Computer” on page 7 and “Before Working Inside Your Computer” on page 8.
- You have read the safety information that shipped with your computer.
- A component can be replaced or—if purchased separately—installed by performing the removal procedure in reverse order.

Recommended Tools

The procedures in this document may require the following tools:

- Small flat-blade screwdriver
- Phillips screwdriver
- Processor extraction tool
- BIOS upgrade CD

Turning Off Your Computer



CAUTION: To avoid losing data, save and close all open files and exit all open programs before you turn off your computer.

1. Save and close all open files and exit all open programs.
2. In Microsoft® Windows Vista®, click **Start** (Windows Vista® logo), click the arrow, and then click **Shut Down**.
The computer turns off after the operating system shutdown process finishes.
3. Ensure that the computer and any attached devices are turned off. If your computer and attached devices did not automatically turn off when you shut down your operating system, press and hold the power button for at least 8 to 10 seconds until the computer turns off.

Before Working Inside Your Computer

Use the following safety guidelines to help protect your computer from potential damage and to help to ensure your own personal safety.



WARNING: Before you begin any of the procedures in this section, follow the safety instructions that shipped with your computer. For additional safety best practices information, see the Regulatory Compliance Homepage at www.dell.com/regulatory_compliance.



CAUTION: Handle components and cards with care. Do not touch the components or contacts on a card. Hold a card by its edges. Hold a component such as a processor by its edges, not by its pins.



CAUTION: Only a certified service technician should perform repairs on your computer. Damage due to servicing that is not authorized by Dell is not covered by your warranty.



CAUTION: When you disconnect a cable, pull on its connector or on its pull-tab, not on the cable itself. Some cables have connectors with locking tabs; if you are disconnecting this type of cable, press in on the locking tabs before you disconnect the cable. As you pull connectors apart, keep them evenly aligned to avoid bending any connector pins. Also, before you connect a cable, ensure that both connectors are correctly oriented and aligned.



CAUTION: To avoid damaging the computer, perform the following steps before you begin working inside the computer.

1. Ensure that the work surface is flat and clean to prevent the computer cover from being scratched.
2. Turn off your computer (see “Turning Off Your Computer” on page 8).
3. If the computer is connected to a docking device (docked), undock it. See the documentation that came with your docking device for instructions.



CAUTION: To disconnect a network cable, first unplug the cable from your computer and then unplug the cable from the network device.

4. Disconnect all telephone or network cables from the computer.
5. Press and eject any installed cards from the ExpressCard slot and the 8-in-1 Memory Card Reader.
6. Disconnect your computer and all attached devices from their electrical outlets.



CAUTION: To help prevent damage to the system board, you must remove the battery from the battery bay before you service the computer.



CAUTION: To avoid damage to the computer, use only the battery designed for this particular Dell computer. Do not use batteries designed for other Dell computers.

7. Remove the battery (see “Removing the Battery Pack” on page 11).
8. Press the power button to ground the system board.

ሥራዎችን ለማግኘት ይጎብኙ

CHAPTER 2: BATTERY PACK

Battery Pack



WARNING: Before working inside your computer, read the safety information that shipped with your computer. For additional safety best practices information, see the Regulatory Compliance Homepage at www.dell.com/regulatory_compliance.



WARNING: Before performing these procedures, turn off the computer, disconnect the AC adapter from the electrical outlet and the computer, disconnect the modem from the wall connector and the computer, and remove any other external cables from the computer.



CAUTION: To avoid electrostatic discharge, ground yourself by using a wrist grounding strap or by periodically touching an unpainted metal surface (such as a connector on the back of the computer).



CAUTION: To help prevent damage to the system board, remove the main battery (see “Removing the Battery Pack” on page 11) before working inside the computer.

Removing the Battery Pack

1. Follow the instructions in “Before You Begin” on page 6.
2. Turn the computer over.
3. Slide the battery latch to the unlock position as shown.
4. The battery pack will pop up.
5. Remove the battery pack.

Replacing the Battery Pack

1. Align the battery pack tabs with the slots in the battery bay.
2. Slide the battery pack into the battery bay until the battery pack clicks into place.

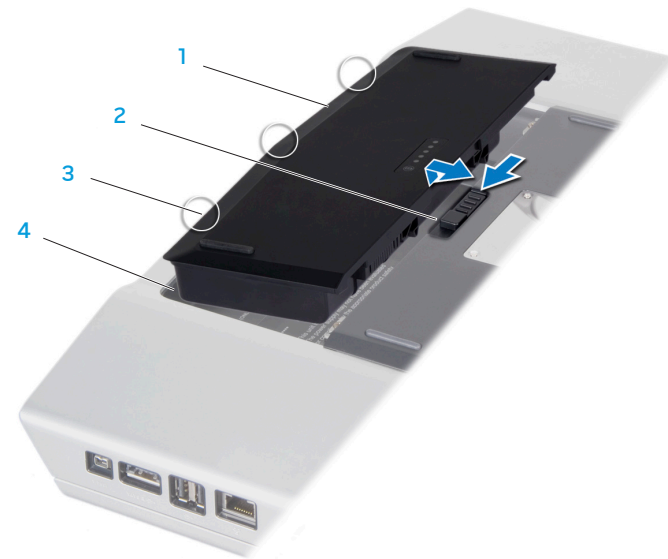

1 battery pack
2 battery latch

3 battery pack tabs (3)
4 battery bay

ህዳር ፩፣ ፳፻፲፯ ዓ.ም.

CHAPTER 3: COMPARTMENT DOOR

Compartment Door



WARNING: Before working inside your computer, read the safety information that shipped with your computer. For additional safety best practices information, see the Regulatory Compliance Homepage at www.dell.com/regulatory_compliance.



WARNING: Before performing these procedures, turn off the computer, disconnect the AC adapter from the electrical outlet and the computer, disconnect the modem from the wall connector and the computer, and remove any other external cables from the computer.



CAUTION: To avoid electrostatic discharge, ground yourself by using a wrist grounding strap or by periodically touching an unpainted metal surface (such as a connector on the back of the computer).



CAUTION: Only a certified service technician should perform repairs on your computer. Damage due to servicing that is not authorized by Dell™ is not covered by your warranty.



CAUTION: To help prevent damage to the system board, remove the main battery (see “Removing the Battery Pack” on page 11) before working inside the computer.

Removing the Compartment Door

1. Follow the instructions in “Before You Begin” on page 6.
2. Remove the battery pack (see “Removing the Battery Pack” on page 11).
3. Loosen the two captive screws and remove the compartment door.

Replacing the Compartment Door

1. Align the compartment door tabs with the slots on the base of the computer.
2. Place the compartment door and tighten the two captive screws.
3. Replace the battery pack (see “Replacing the Battery Pack” on page 11).

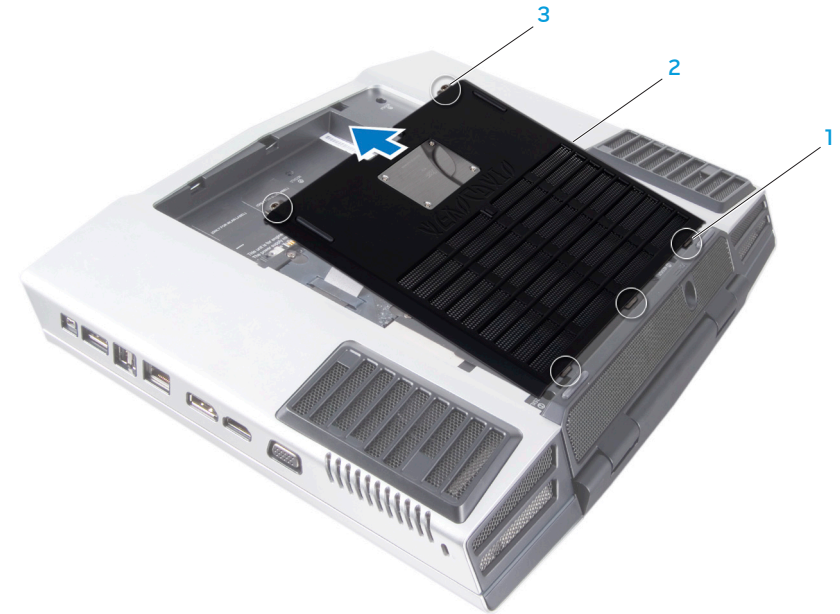

1 compartment door tabs (3)

2 compartment door

3 captive screws (2)



CHAPTER 4: HARD DRIVE(S)

Hard Drive(s)



WARNING: Before working inside your computer, read the safety information that shipped with your computer. For additional safety best practices information, see the Regulatory Compliance Homepage at www.dell.com/regulatory_compliance.



WARNING: If you remove the hard drive from the computer when the drive is hot, *do not touch* the metal housing of the hard drive.



CAUTION: To prevent data loss, turn off your computer (see “Turning Off Your Computer” on page 7) before removing the hard drive. Do not remove the hard drive while the computer is on or in Sleep state.



CAUTION: Hard drives are extremely fragile. Exercise care when handling the hard drive.



CAUTION: To avoid electrostatic discharge, ground yourself by using a wrist grounding strap or by periodically touching an unpainted metal surface (such as a connector on the back of the computer).



CAUTION: Only a certified service technician should perform repairs on your computer. Damage due to servicing that is not authorized by Dell™ is not covered by your warranty.



CAUTION: To help prevent damage to the system board, remove the main battery (see “Removing the Battery Pack” on page 11) before working inside the computer.



NOTE: Dell does not guarantee compatibility or provide support for hard drives from sources other than Dell or Alienware.



NOTE: If you are installing a hard drive from a source other than Dell or Alienware, you need to install an operating system, drivers, and utilities on the new hard drive.

Removing the Hard Drive(s)

1. Follow the instructions in “Before You Begin” on page 6.
2. Remove the battery pack (see “Removing the Battery Pack” on page 11).
3. Remove the compartment door (see “Removing the Compartment Door” on page 14).
4. Loosen the four captive screws that secure the primary hard drive (HDD0).
5. Using the pull tab, slide the primary hard drive (HDD0) towards the back of the hard drive bay and lift it out.

Primary Hard Drive (HDD0)

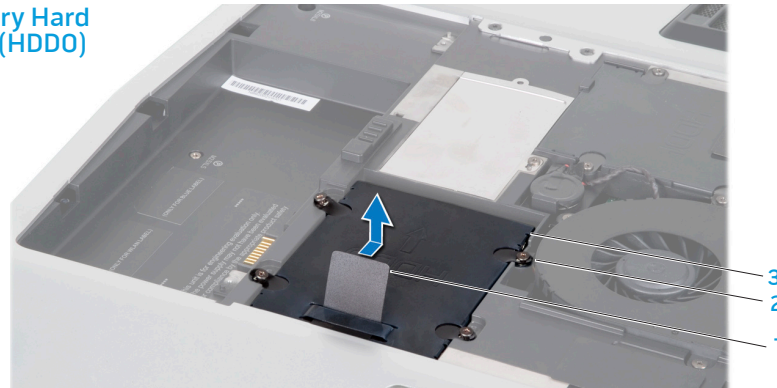

- 1 pull tab
- 2 captive screws (4)

- 3 primary hard drive (HDD0)

6. If your computer has a secondary hard drive (HDD1):
 - a. Loosen the four captive screws on the secondary hard drive (HDD1).
 - b. Using the pull tab, lift the secondary hard drive (HDD1) out of the hard drive bay.

Secondary Hard Drive (HDD1)

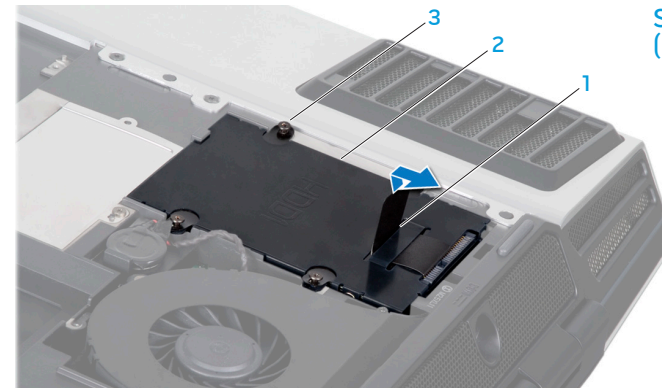

- 1 pull tab
- 2 secondary hard drive (HDD1)

- 3 captive screws (4)

7. Remove the four screws that secure the hard drive bracket to the hard drive.
8. Slide the hard drive out of the hard drive bracket.



- 1 screws (4)
- 2 hard drive bracket

3 hard drive

9. Remove the interposer from the secondary hard drive (HDD1), if applicable.

Secondary Hard Drive (HDD1)

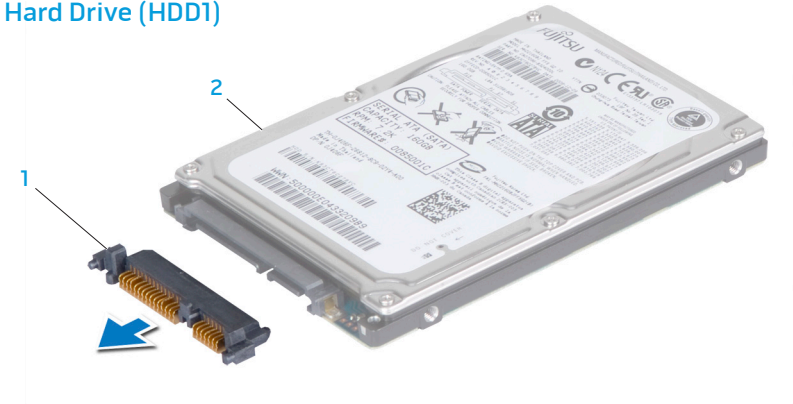

1 interposer

2 secondary hard drive (HDD1)

Replacing the Hard Drive(s)

1. Remove the new drive from its packaging.
Save the original packaging for storing or shipping the hard drive.



CAUTION: Use firm and even pressure to slide the drive into place. If you use excessive force, you may damage the connector.

2. Connect the interposer to the secondary hard drive (HDD1), if applicable.
3. Slide the hard drive into the hard drive bracket.
4. Replace the four screws that secure the hard drive bracket to the hard drive.
5. Place the hard drive in the hard drive bay.
 - a. If your computer has a secondary hard drive (HDD1), align and tighten the four captive screws that secure the hard drive to the hard drive bay.
 - b. Align and and tighten the four captive screws that secure the primary hard drive (HDD0) to the hard drive bay.

6. Replace the compartment door (see “Replacing the Compartment Door” on page 14).
7. Replace the battery pack (see “Replacing the Battery Pack” on page 11).



CAUTION: Before turning on the computer, replace all screws and ensure that no stray screws remain inside the computer. Failure to do so may result in damage to the computer.

8. Install the operating system for your computer, as needed.
9. Install the drivers and utilities for your computer, as needed.

ህዳር ፩፣ ፳፻፲፯ ዓ.ም. ለአዲስ አበባ

CHAPTER 5: PROCESSOR THERMAL FAN

Processor Thermal Fan



WARNING: Before working inside your computer, read the safety information that shipped with your computer. For additional safety best practices information, see the Regulatory Compliance Homepage at www.dell.com/regulatory_compliance.



CAUTION: To avoid electrostatic discharge, ground yourself by using a wrist grounding strap or by periodically touching an unpainted metal surface (such as a connector on the back of the computer).



CAUTION: Only a certified service technician should perform repairs on your computer. Damage due to servicing that is not authorized by Dell™ is not covered by your warranty.



CAUTION: To help prevent damage to the system board, remove the main battery (see "Removing the Battery Pack" on page 11) before working inside the computer.

Removing the Processor Thermal Fan

1. Follow the instructions in “Before You Begin” on page 6.
2. Remove the battery pack (see “Removing the Battery Pack” on page 11).
3. Remove the compartment door (see “Removing the Compartment Door” on page 14).
4. Loosen the three captive screws that secure the processor thermal fan to the computer.
5. Disconnect the processor thermal fan cable from the system board connector.
6. Lift the processor thermal fan off the computer.

Replacing the Processor Thermal Fan

1. Place the processor thermal fan on the computer base.
2. Connect the processor thermal fan cable to the system board connector.
3. Tighten the three captive screws that secure the processor thermal fan to the computer base.
4. Replace the compartment door (see “Replacing the Compartment Door” on page 14).
5. Replace the battery pack (see “Replacing the Battery Pack” on page 11).



CAUTION: Before turning on the computer, replace all screws and ensure that no stray screws remain inside the computer. Failure to do so may result in damage to the computer.

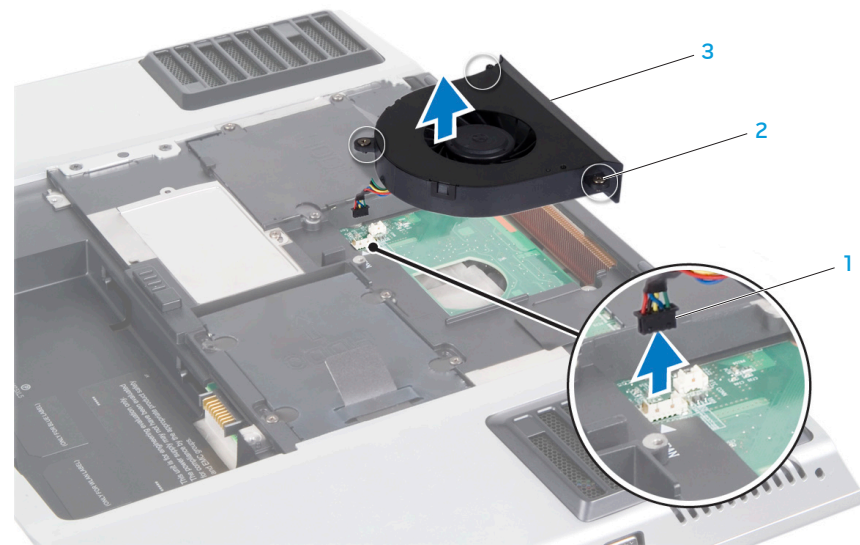

1 processor thermal fan cable connector

2 captive screws (3)

3 processor thermal fan

ህዳር ፩፣ ፳፻፲፯ ዓ.ም.

CHAPTER 6: COIN-CELL BATTERY

Coin-Cell Battery



WARNING: Before working inside your computer, read the safety information that shipped with your computer. For additional safety best practices information, see the Regulatory Compliance Homepage at www.dell.com/regulatory_compliance.



CAUTION: To avoid electrostatic discharge, ground yourself by using a wrist grounding strap or by periodically touching an unpainted metal surface (such as a connector on the back of the computer).



CAUTION: Only a certified service technician should perform repairs on your computer. Damage due to servicing that is not authorized by Dell™ is not covered by your warranty.



CAUTION: To help prevent damage to the system board, remove the main battery (see “Removing the Battery Pack” on page 11) before working inside the computer.

Removing the Coin-Cell Battery

1. Follow the instructions in “Before You Begin” on page 6.
2. Remove the battery pack (see “Removing the Battery Pack” on page 11).
3. Remove the compartment door (see “Removing the Compartment Door” on page 14).
4. Disconnect the coin-cell battery cable from the system board connector.
5. Lift the coin-cell battery off the computer base.

Replacing the Coin-Cell Battery

1. Place the coin-cell battery in the slot on the computer base.
2. Connect the coin-cell battery cable to the system board connector.
3. Replace the compartment door (see “Replacing the Compartment Door” on page 14).
4. Replace the battery pack (see “Replacing the Battery Pack” on page 11).



CAUTION: Before turning on the computer, replace all screws and ensure that no stray screws remain inside the computer. Failure to do so may result in damage to the computer.

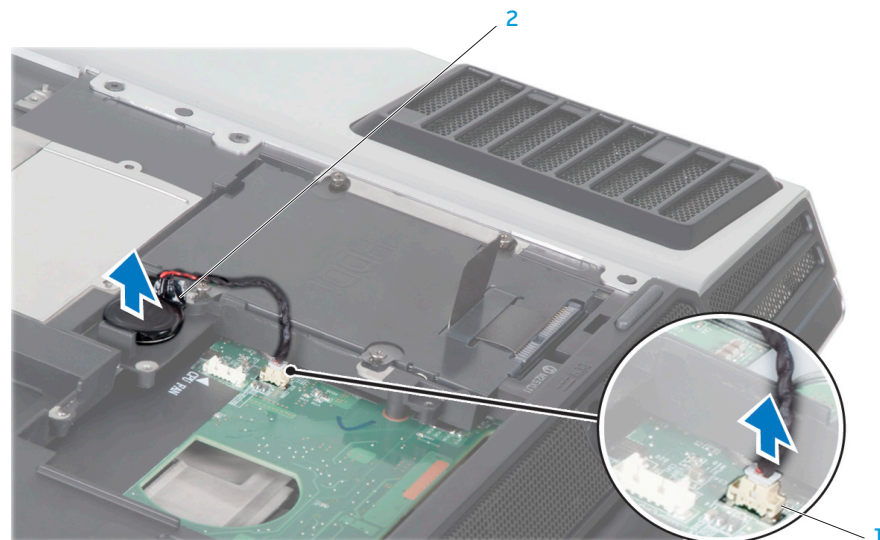

1 coin-cell battery cable connector

2 coin-cell battery



CHAPTER 7: MEMORY MODULE(S)

You can increase your computer memory by installing memory modules on the system board. See the specifications in your Mobile Manual or in the Comprehensive Specifications at support.dell.com for information on the memory supported by your computer. Install only memory modules that are supported by your computer.



NOTE: Memory modules purchased from Dell are covered under your computer warranty.

Your computer has two user-accessible SODIMM sockets that can be accessed from the bottom of the computer.

Memory Module(s)



WARNING: Before working inside your computer, read the safety information that shipped with your computer. For additional safety best practices information, see the Regulatory Compliance Homepage at www.dell.com/regulatory_compliance.



CAUTION: To avoid electrostatic discharge, ground yourself by using a wrist grounding strap or by periodically touching an unpainted metal surface (such as a connector on the back of the computer).



CAUTION: Only a certified service technician should perform repairs on your computer. Damage due to servicing that is not authorized by Dell™ is not covered by your warranty.



CAUTION: To help prevent damage to the system board, remove the main battery (see "Removing the Battery Pack" on page 11) before working inside the computer.

Removing the Memory Module(s)

1. Follow the instructions in "Before You Begin" on page 6.
2. Remove the battery pack (see "Removing the Battery Pack" on page 11).
3. Remove the compartment door (see "Removing the Compartment Door" on page 14).
4. Loosen the captive screw and slide the memory module door out of the computer base.



CAUTION: If you need to remove memory modules from both connectors, remove the memory module in the upper connector before you remove the module in the lower connector.

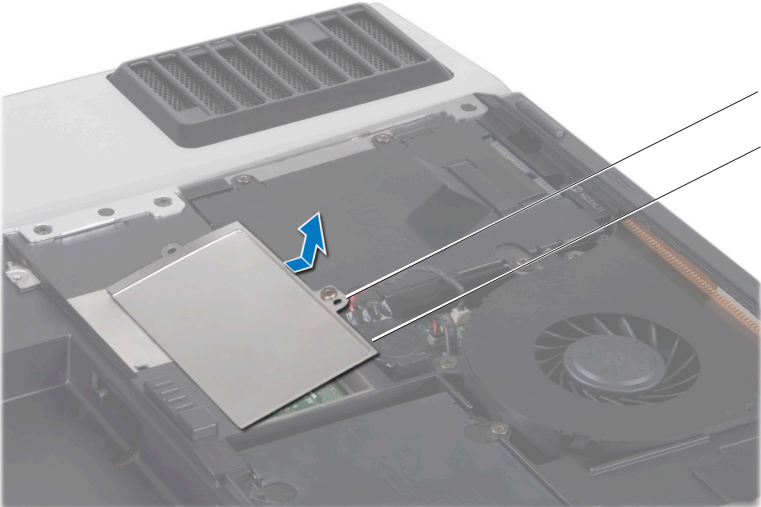

1 memory module door

2 captive screw

- Use your fingertips to carefully spread apart the spring-locks on the memory module connector until the module pops up.
- Remove the memory module.

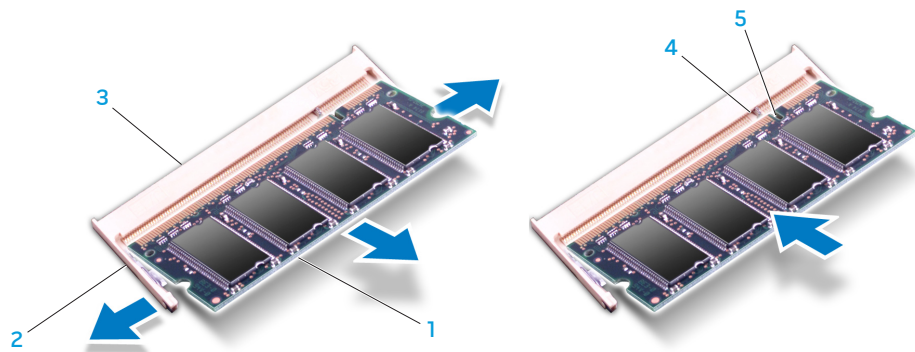

- 1 memory module
- 2 spring locks (2)
- 3 memory module connector

- 4 tab
- 5 notch

Replacing the Memory Module(s)



CAUTION: If you need to install memory modules in two connectors, install a memory module in the lower connector before you install a module in the upper connector.

- Align the notch on the memory module with the tab on the memory module connector.
- Insert the module into the memory module connector at a 45-degree angle, and press the module down until it clicks into place. If you do not hear the click, remove the module and reinstall it.



CAUTION: If the memory module door is difficult to close, remove the memory module and reinstall it. Forcing the memory module door to close may damage your computer.



NOTE: If the memory module is not installed properly, the computer may not boot.

3. Replace and tighten the captive screw that secures the memory module door to the computer base.
4. Replace the compartment door (see “Replacing the Compartment Door” on page 14).
5. Replace the battery pack (see “Replacing the Battery Pack” on page 11).



CAUTION: Before turning on the computer, replace all screws and ensure that no stray screws remain inside the computer. Failure to do so may result in damage to the computer.

6. Turn on the computer.
As the computer boots, it detects the additional memory and automatically updates the system configuration information.

To confirm the amount of memory installed in the computer, click **Start** (Windows Vista® logo) > **Help and Support** > **Dell System Information**.

ህዝብ ስለ ህዝብ ህዝብ ህዝብ

CHAPTER 8: CENTER CONTROL COVER

Center Control Cover



WARNING: Before working inside your computer, read the safety information that shipped with your computer. For additional safety best practices information, see the Regulatory Compliance Homepage at www.dell.com/regulatory_compliance.



CAUTION: To avoid electrostatic discharge, ground yourself by using a wrist grounding strap or by periodically touching an unpainted metal surface (such as a connector on the back of the computer).



CAUTION: Only a certified service technician should perform repairs on your computer. Damage due to servicing that is not authorized by Dell™ is not covered by your warranty.



CAUTION: To help prevent damage to the system board, remove the main battery (see "Removing the Battery Pack" on page 11) before working inside the computer.

Removing the Center Control Cover

1. Follow the instructions in "Before You Begin" on page 6.
2. Remove the battery pack (see "Removing the Battery Pack" on page 11).
3. Remove the compartment door (see "Removing the Compartment Door" on page 14).
4. Remove the two screws that secure the center control cover to the computer base.

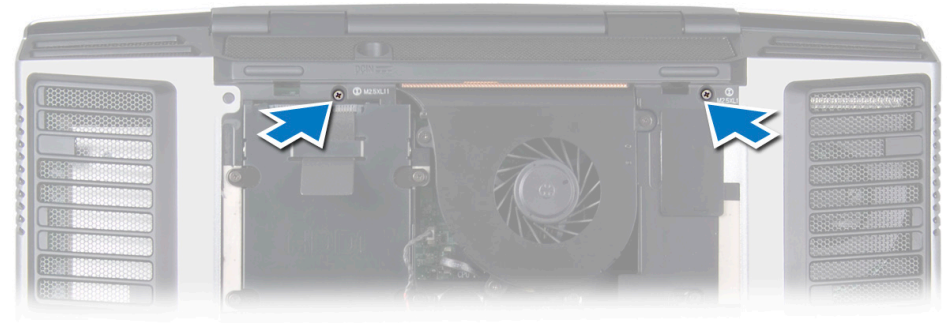

- Turn the computer top side up, and open the display as far as it will open.



CAUTION: Be extremely careful when removing the center control cover. The center control cover along with the cable that attaches it to the system board connector are very fragile.

- Pry the center control cover up with a flat blade screwdriver until you see the cable that attaches the center control cover to the system board connector.



1 center control cover

- Turn the center control cover as shown in the illustration.
- Release the connector latch to disconnect the cable from the center control cover connector.
- Lift the center control cover off the computer.

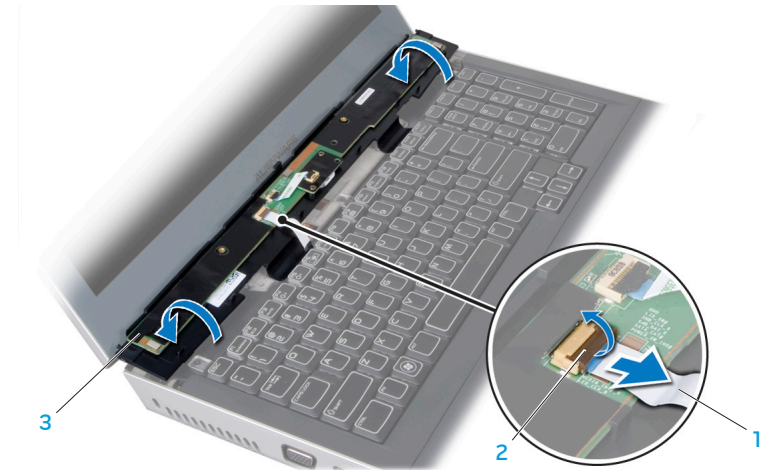

1 cable

2 connector latch

3 center control cover

Replacing the Center Control Cover

1. Slide the cable into the center control cover connector and pull down the connector latch to secure the cable to the connector.
2. Align the center control cover with the computer and snap the cover in place.
3. Turn the computer over and replace the two screws that secure the center control cover to the computer base.
4. Replace the compartment door (see “Replacing the Compartment Door” on page 14).
5. Replace the battery pack (see “Replacing the Battery Pack” on page 11).



CAUTION: Before turning on the computer, replace all screws and ensure that no stray screws remain inside the computer. Failure to do so may result in damage to the computer.

מפתח ה-ESC: מפתח

CHAPTER 9: KEYBOARD

Keyboard



WARNING: Before working inside your computer, read the safety information that shipped with your computer. For additional safety best practices information, see the Regulatory Compliance Homepage at www.dell.com/regulatory_compliance.



CAUTION: To avoid electrostatic discharge, ground yourself by using a wrist grounding strap or by periodically touching an unpainted metal surface (such as a connector on the back of the computer).



CAUTION: Only a certified service technician should perform repairs on your computer. Damage due to servicing that is not authorized by Dell™ is not covered by your warranty.



CAUTION: To help prevent damage to the system board, remove the main battery (see "Removing the Battery Pack" on page 11) before working inside the computer.

Removing the Keyboard

1. Follow the instructions in “Before You Begin” on page 6.
2. Remove the battery pack (see “Removing the Battery Pack” on page 11).
3. Remove the center control cover (see “Removing the Center Control Cover” on page 33).
4. Remove the five screws that secure the keyboard to the computer.



CAUTION: Be extremely careful when removing the keyboard. The keyboard along with the cables that attach it to the system board connector are very fragile.

5. Slide and lift the keyboard towards the display until the tabs come out of the slots on the chassis.

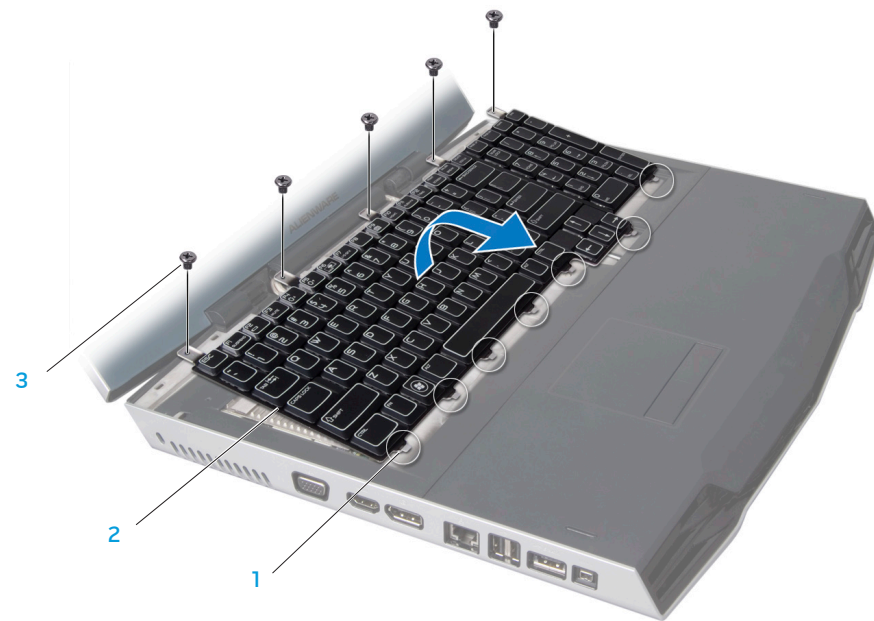

1 tabs (7)

2 keyboard

3 screws (5)

6. Turn the keyboard over.
7. Release the connector latches and disconnect the keyboard cable and keyboard light cable from the respective system board connectors.
8. Lift the keyboard off the computer.

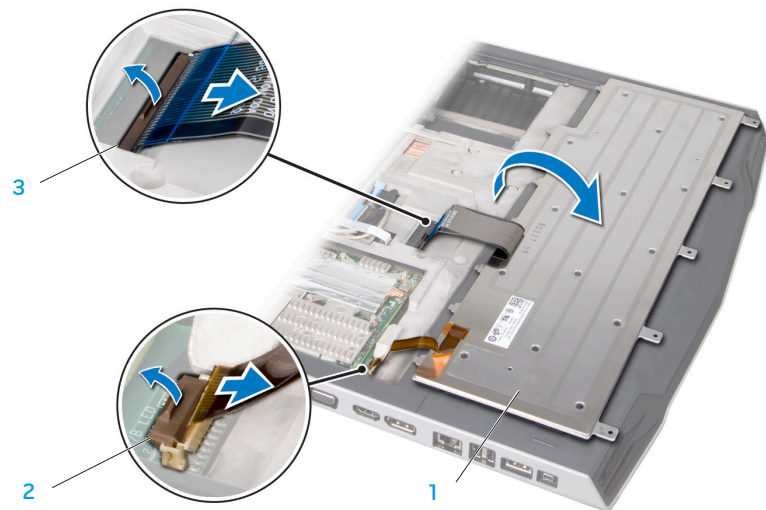

1 keyboard

2 keyboard light cable

3 keyboard cable

Replacing the Keyboard

1. Slide the keyboard cable and the keyboard light cable into the respective system board connectors and pull down the connector latches to secure the cables to the connectors.
2. Align the tabs on the keyboard with the slots on the chassis.
3. Replace the five screws that secure the keyboard to the computer base.
4. Replace the center control cover (see "Replacing the Center Control Cover" on page 35).
5. Replace the battery pack (see "Replacing the Battery Pack" on page 11).



CAUTION: Before turning on the computer, replace all screws and ensure that no stray screws remain inside the computer. Failure to do so may result in damage to the computer.

ህዳር ፳፯፣ ፳፻፲፱

CHAPTER 10: PALM REST

Palm Rest



WARNING: Before working inside your computer, read the safety information that shipped with your computer. For additional safety best practices information, see the Regulatory Compliance Homepage at www.dell.com/regulatory_compliance.



CAUTION: To avoid electrostatic discharge, ground yourself by using a wrist grounding strap or by periodically touching an unpainted metal surface (such as a connector on the back of the computer).



CAUTION: Only a certified service technician should perform repairs on your computer. Damage due to servicing that is not authorized by Dell™ is not covered by your warranty.



CAUTION: To help prevent damage to the system board, remove the main battery (see "Removing the Battery Pack" on page 11) before working inside the computer.

Removing the Palm Rest

1. Follow the instructions in “Before You Begin” on page 6.
2. Remove the battery pack (see “Removing the Battery Pack” on page 11).
3. Remove the three screws that secure the palm rest to the computer base.



1 screws (3)

2 battery bay

- Turn the computer over and slide the palm rest out as shown in the illustration.



CAUTION: Be extremely careful when removing the palm rest. The palm rest along with the cable that attaches the touch pad to the system board connector are very fragile.



1 palm rest

2 tabs (5)

- Ease the palm rest up until you see the cable that attaches the touch pad to the system board connector.
- Turn the palm rest over and pull the tab on the touch pad connector to disconnect the cable from the touch pad connector.
- Lift the palm rest off the computer.

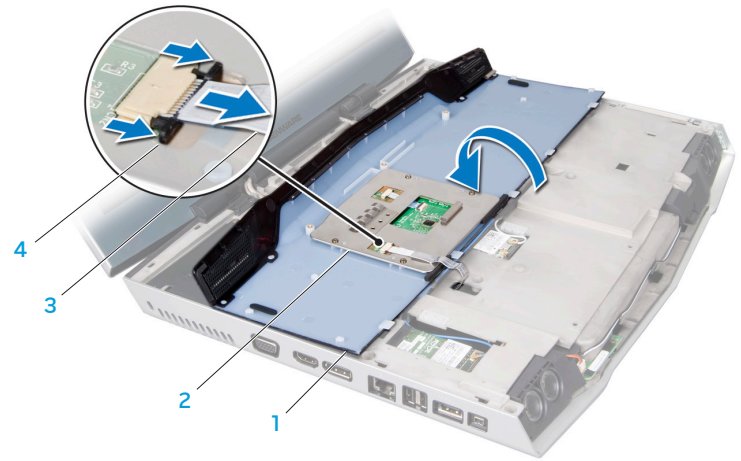

1 palm rest

2 touch pad

3 touch pad cable

4 tab on the touch pad connector

Replacing the Palm Rest

1. Slide the touch pad cable into the touch pad connector and push the connector tabs to secure the cable to the connector.
2. Align the tabs on the palm rest with the slots on the computer.
3. Slide the palm rest into position.
4. Turn the computer over and replace the three screws that secure the palm rest to the computer base.
5. Replace the battery pack (see “Replacing the Battery Pack” on page 11).



CAUTION: Before turning on the computer, replace all screws and ensure that no stray screws remain inside the computer. Failure to do so may result in damage to the computer.

—XVXVI 88: XIV—XVX

CHAPTER 11: BRACKETS

Brackets



WARNING: Before working inside your computer, read the safety information that shipped with your computer. For additional safety best practices information, see the Regulatory Compliance Homepage at www.dell.com/regulatory_compliance.



CAUTION: To avoid electrostatic discharge, ground yourself by using a wrist grounding strap or by periodically touching an unpainted metal surface (such as a connector on the back of the computer).



CAUTION: Only a certified service technician should perform repairs on your computer. Damage due to servicing that is not authorized by Dell™ is not covered by your warranty.



CAUTION: To help prevent damage to the system board, remove the main battery (see "Removing the Battery Pack" on page 11) before working inside the computer.

Removing the Brackets

1. Follow the instructions in “Before You Begin” on page 6.
2. Remove the battery pack (see “Removing the Battery Pack” on page 11).
3. Remove the center control cover (see “Removing the Center Control Cover” on page 33).
4. Remove the keyboard (see “Removing the Keyboard” on page 38).
5. Loosen the four captive screws that secure the left and right brackets to the computer base.
6. Lift the left and right brackets off the computer.

Replacing the Brackets

1. Replace the left and right brackets on the computer base.
2. Tighten the four captive screws that secure the left and right brackets to the computer base.
3. Replace the keyboard (see “Replacing the Keyboard” on page 39).
4. Replace the center control cover (see “Replacing the Center Control Cover” on page 35).
5. Replace the battery pack (see “Replacing the Battery Pack” on page 11).



CAUTION: Before turning on the computer, replace all screws and ensure that no stray screws remain inside the computer. Failure to do so may result in damage to the computer.

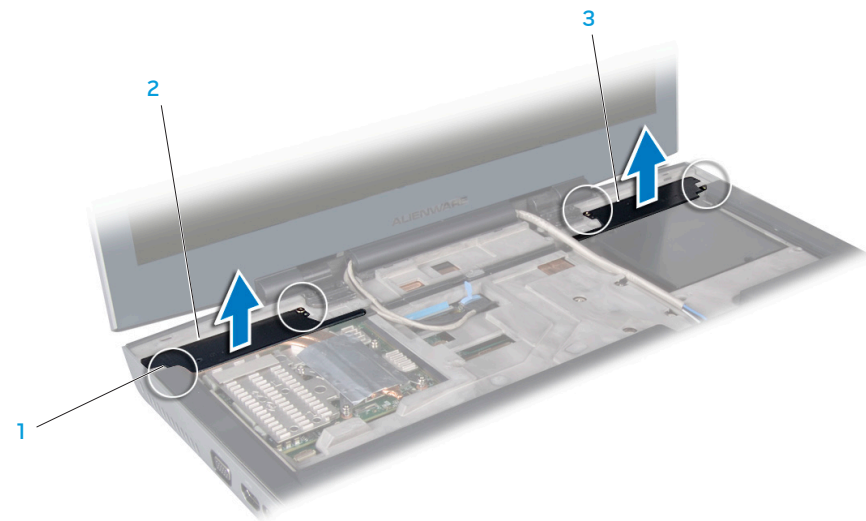

1 captive screws (4)

2 left bracket

3 right bracket

מגנזיום: כיסוי המגנזיום

CHAPTER 12: MAGNESIUM COVER

Magnesium Cover



WARNING: Before working inside your computer, read the safety information that shipped with your computer. For additional safety best practices information, see the Regulatory Compliance Homepage at www.dell.com/regulatory_compliance.



CAUTION: To avoid electrostatic discharge, ground yourself by using a wrist grounding strap or by periodically touching an unpainted metal surface (such as a connector on the back of the computer).



CAUTION: Only a certified service technician should perform repairs on your computer. Damage due to servicing that is not authorized by Dell™ is not covered by your warranty.



CAUTION: To help prevent damage to the system board, remove the main battery (see "Removing the Battery Pack" on page 11) before working inside the computer.

Removing the Magnesium Cover

1. Follow the instructions in “Before You Begin” on page 6.
2. Remove the battery pack (see “Removing the Battery Pack” on page 11).
3. Remove the center control cover (see “Removing the Center Control Cover” on page 33).
4. Remove the keyboard (see “Removing the Keyboard” on page 38).
5. Remove the palm rest (see “Removing the Palm Rest” on page 42).
6. Disconnect the antenna cables from the respective Mini-Cards and remove these cables from their routing guides.
7. Disconnect the display cable and the camera cable from the respective system board connectors.

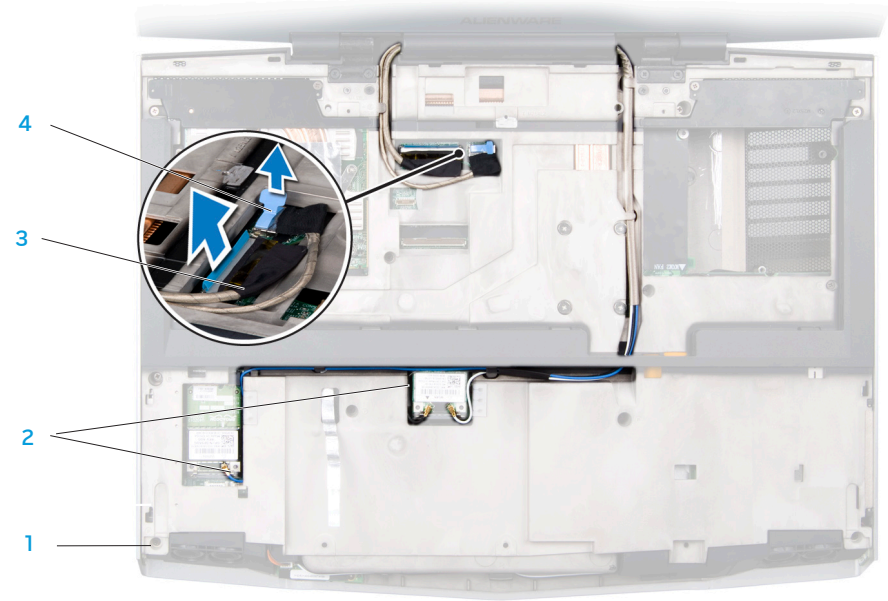

1 magnesium cover

2 Mini-Card antenna cables

3 display cable

4 camera cable

8. Remove the left and right brackets (see “Removing the Brackets” on page 47).
9. Remove the ten screws that secure the magnesium cover to the computer base.
10. Lift the magnesium cover off the computer.

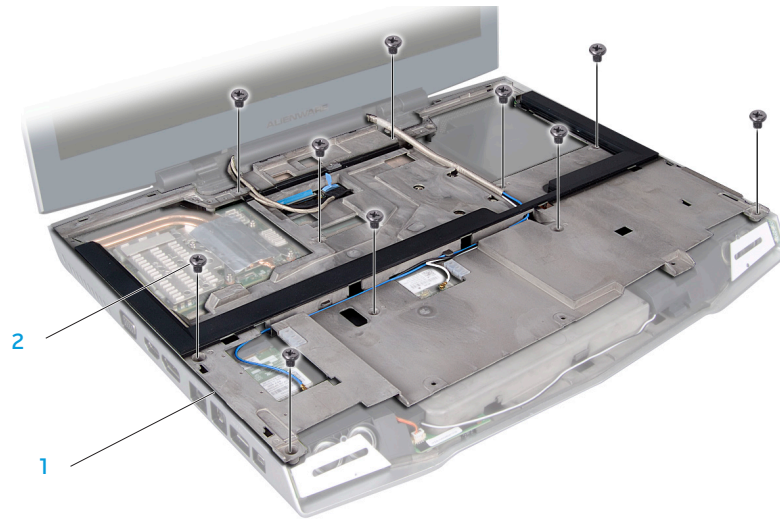

1 magnesium cover

2 screws (10)

Replacing the Magnesium Cover

1. Replace the magnesium cover on the computer base.
2. Replace the ten screws that secure the magnesium cover to the computer base.
3. Replace the left and right brackets (see “Replacing the Brackets” on page 47).
4. Route the Mini-Card antenna cables into the routing guides and connect them to the respective connectors.
5. Connect the display cable and the camera cable to the respective system board connectors.
6. Replace the palm rest (see “Replacing the Palm Rest” on page 44).
7. Replace the keyboard (see “Replacing the Keyboard” on page 39).
8. Replace the center control cover (see “Replacing the Center Control Cover” on page 35).
9. Replace the battery pack (see “Replacing the Battery Pack” on page 11).



CAUTION: Before turning on the computer, replace all screws and ensure that no stray screws remain inside the computer. Failure to do so may result in damage to the computer.

~XVCXVI 33: WXCXW

CHAPTER 13: DISPLAY

Display



WARNING: Before working inside your computer, read the safety information that shipped with your computer. For additional safety best practices information, see the Regulatory Compliance Homepage at www.dell.com/regulatory_compliance.



CAUTION: To avoid electrostatic discharge, ground yourself by using a wrist grounding strap or by periodically touching an unpainted metal surface (such as a connector on the back of the computer).



CAUTION: Only a certified service technician should perform repairs on your computer. Damage due to servicing that is not authorized by Dell™ is not covered by your warranty.



CAUTION: To help prevent damage to the system board, remove the main battery (see “Removing the Battery Pack” on page 11) before working inside the computer.



CAUTION: To avoid damage to the display, you must not disassemble your Edge-to-Edge display assembly in the field.

Display Assembly

Removing the Display Assembly

1. Follow the instructions in “Before You Begin” on page 6.
2. Remove the battery pack (see “Removing the Battery Pack” on page 11).
3. Remove the center control cover (see “Removing the Center Control Cover” on page 33).
4. Remove the keyboard (see “Removing the Keyboard” on page 38).
5. Remove the palm rest (see “Removing the Palm Rest” on page 42).
6. Remove the left and right brackets (see “Removing the Brackets” on page 47).
7. Remove the magnesium cover (see “Removing the Magnesium Cover” on page 50).

8. Remove the four screws (two from each hinge) that secure the display assembly to the computer base.



1 screws (4)

2 display assembly

9. Bend the display assembly towards the computer base at a 45-degree angle and lift the display assembly off the computer.

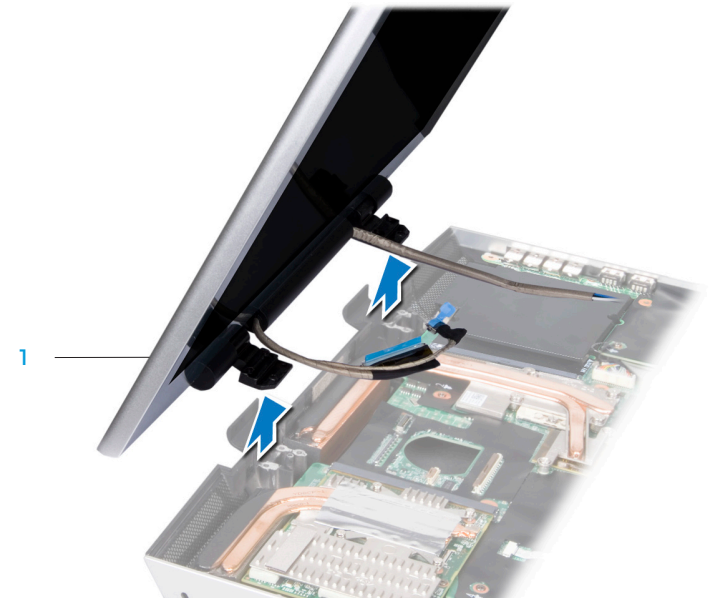

1 display assembly

Replacing the Display Assembly

1. Align the screw holes on the display hinges with the computer base.
2. Replace the four screws (two on each hinge) that secure the display assembly to the computer base.
3. Replace the magnesium cover (see “Replacing the Magnesium Cover” on page 51).
4. Replace the left and right brackets (see “Replacing the Brackets” on page 47).
5. Replace the palm rest (see “Replacing the Palm Rest” on page 44).
6. Replace the keyboard (see “Replacing the Keyboard” on page 39).
7. Replace the center control cover (see “Replacing the Center Control Cover” on page 35).
8. Replace the battery pack (see “Replacing the Battery Pack” on page 11).



CAUTION: Before turning on the computer, replace all screws and ensure that no stray screws remain inside the computer. Failure to do so may result in damage to the computer.

Display Back Cover

Removing the Display Back Cover

1. Follow the instructions in “Before You Begin” on page 6.
2. Remove the battery pack (see “Removing the Battery Pack” on page 11).
3. Remove the center control cover (see “Removing the Center Control Cover” on page 33).
4. Remove the keyboard (see “Removing the Keyboard” on page 38).
5. Remove the palm rest (see “Removing the Palm Rest” on page 42).
6. Remove the left and right brackets (see “Removing the Brackets” on page 47).
7. Remove the magnesium cover (see “Removing the Magnesium Cover” on page 50).
8. Remove the display assembly (see “Removing the Display Assembly” on page 53).
9. Remove the two screws that secure the display back cover door to the display assembly.

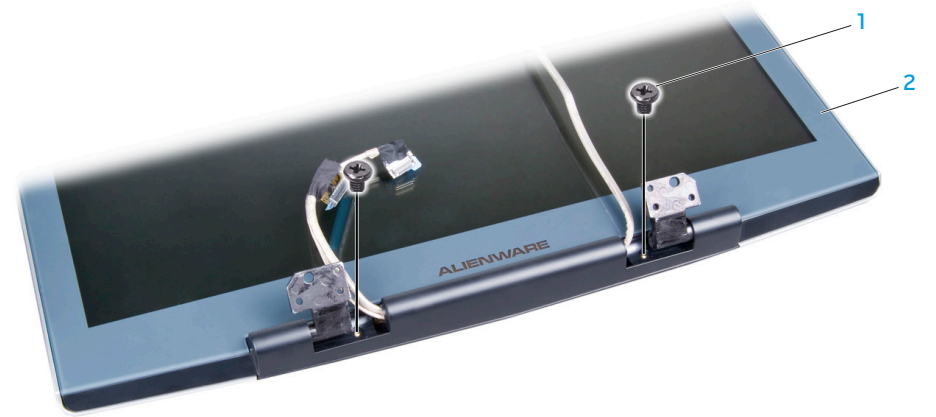

1 screws (2)

2 display assembly

10. Slide the display back cover door out and lift it off the display assembly.

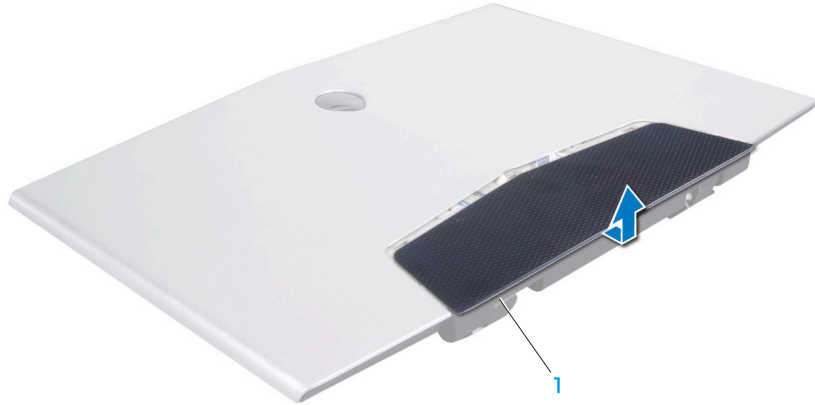

1 display back cover door

11. Remove the two screws that secure the display back cover to the display assembly.
12. Disconnect the AlienHead cable from the connector.
13. Slide the display back cover up and lift it off the display assembly.

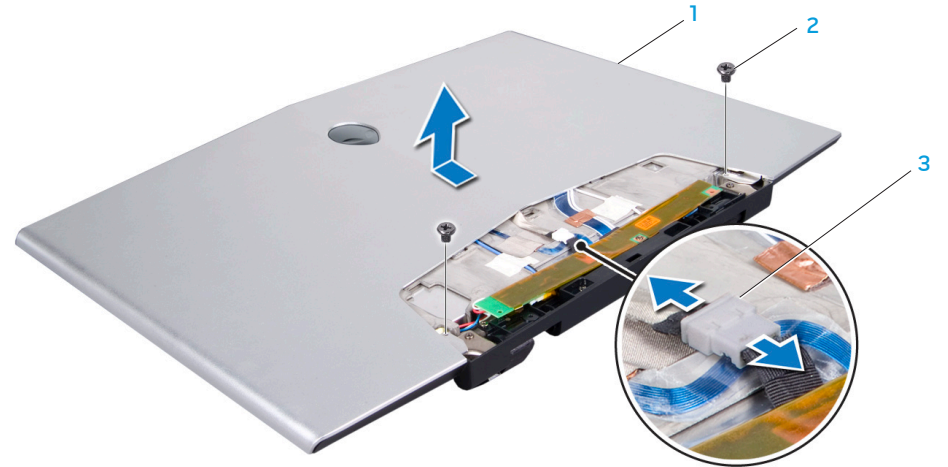

1 display back cover

2 screws (2)

3 AlienHead cable connector

Replacing the Display Back Cover

1. Align the display back cover with the back of the display assembly and slide it into position.
2. Connect the AlienHead cable to the connector.
3. Replace the two screws that secure the display back cover with the display assembly.
4. Slide the display back cover door in place.
5. Turn the display assembly over and replace the two screws that secure the display back cover door to the display assembly.
6. Replace the display assembly (see “Replacing the Display Assembly” on page 55).
7. Replace the magnesium cover (see “Replacing the Magnesium Cover” on page 51).
8. Replace the left and right brackets (see “Replacing the Brackets” on page 47).
9. Replace the palm rest (see “Replacing the Palm Rest” on page 44).
10. Replace the keyboard (see “Replacing the Keyboard” on page 39).
11. Replace the center control cover (see “Replacing the Center Control Cover” on page 35).
12. Replace the battery pack (see “Replacing the Battery Pack” on page 11).



CAUTION: Before turning on the computer, replace all screws and ensure that no stray screws remain inside the computer. Failure to do so may result in damage to the computer.

AlienHead Board

Removing the AlienHead Board

1. Follow the instructions in “Before You Begin” on page 6.
2. Remove the battery pack (see “Removing the Battery Pack” on page 11).
3. Remove the center control cover (see “Removing the Center Control Cover” on page 33).
4. Remove the keyboard (see “Removing the Keyboard” on page 38).
5. Remove the palm rest (see “Removing the Palm Rest” on page 42).
6. Remove the left and right brackets (see “Removing the Brackets” on page 47).
7. Remove the magnesium cover (see “Removing the Magnesium Cover” on page 50).
8. Remove the display assembly (see “Removing the Display Assembly” on page 53).
9. Remove the display back cover (see “Removing the Display Back Cover” on page 56).
10. Turn the display back cover over.
11. Remove the screw that secures the AlienHead board to the display back cover.

12. Lift the top of the AlienHead board and slide the bottom portion down to detach it from the tab that holds it in place.
13. Lift the AlienHead board off the display back cover.

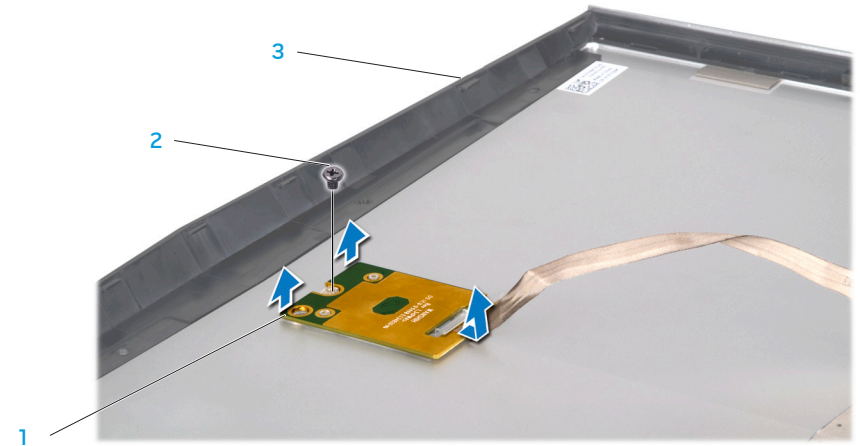

1 AlienHead board

2 screw

3 display back cover

Replacing the AlienHead Board

1. Align the AlienHead board with the tab on the display back cover and slide it into position.
2. Replace the screw that secures the AlienHead board to the display back cover.
3. Replace the display back cover (see “Replacing the Display Back Cover” on page 58).
4. Replace the display assembly (see “Replacing the Display Assembly” on page 55).
5. Replace the magnesium cover (see “Replacing the Magnesium Cover” on page 51).
6. Replace the left and right brackets (see “Replacing the Brackets” on page 47).
7. Replace the palm rest (see “Replacing the Palm Rest” on page 44).
8. Replace the keyboard (see “Replacing the Keyboard” on page 39).
9. Replace the center control cover (see “Replacing the Center Control Cover” on page 35).
10. Replace the battery pack (see “Replacing the Battery Pack” on page 11).



CAUTION: Before turning on the computer, replace all screws and ensure that no stray screws remain inside the computer. Failure to do so may result in damage to the computer.

ህዳር ፳፯፣ ፳፻፲፯ ዓ.ም. ግብርና/ፎካል ግብር

CHAPTER 14: INPUT/OUTPUT BOARD

Input/Output Board



WARNING: Before working inside your computer, read the safety information that shipped with your computer. For additional safety best practices information, see the Regulatory Compliance Homepage at www.dell.com/regulatory_compliance.



CAUTION: To avoid electrostatic discharge, ground yourself by using a wrist grounding strap or by periodically touching an unpainted metal surface (such as a connector on the back of the computer).



CAUTION: Only a certified service technician should perform repairs on your computer. Damage due to servicing that is not authorized by Dell™ is not covered by your warranty.



CAUTION: To help prevent damage to the system board, remove the main battery (see “Removing the Battery Pack” on page 11) before working inside the computer.

Removing the Input/Output Board

1. Follow the instructions in “Before You Begin” on page 6.
2. Remove the battery pack (see “Removing the Battery Pack” on page 11).
3. Remove the center control cover (see “Removing the Center Control Cover” on page 33).
4. Remove the keyboard (see “Removing the Keyboard” on page 38).
5. Remove the palm rest (see “Removing the Palm Rest” on page 42).
6. Remove the left and right brackets (see “Removing the Brackets” on page 47).
7. Remove the magnesium cover (see “Removing the Magnesium Cover” on page 50).

8. Release the connector latches on both ends of the ExpressCard cable and remove the cable.

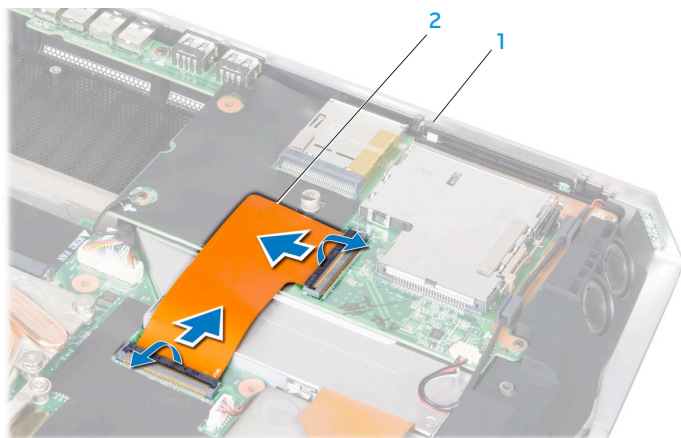

1 input/output board

2 ExpressCard cable

9. Disconnect the speaker cable, right speaker light cable, and audio cable from the respective connectors on the system board and remove the cables from the routing guides.

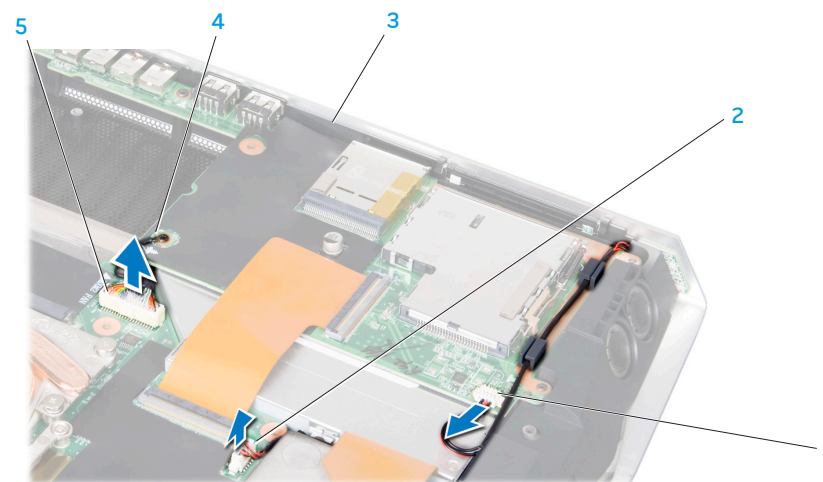

1 speaker cable connector

4 earthing cable

2 right speaker light cable connector

5 audio cable connector

3 input/output board

10. Remove the three screws that secure the input/output board to the system board and remove the earthing cable.
11. Tilt the input/output board at an angle and lift it out of the computer base.

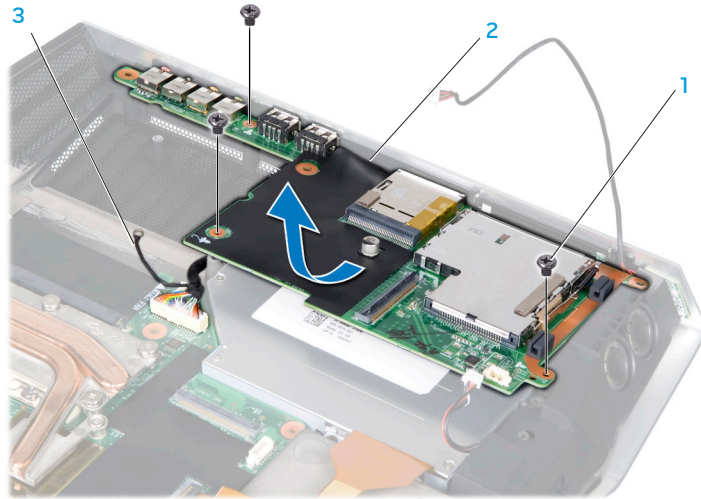

- 1 screws (3)
2 input/output board

- 3 earthing cable

Replacing the Input/Output Board

1. Place the input/output board in the computer base.
2. Replace the earthing cable and the three screws that secure the input/output board to the system board.
3. Route and connect the speaker cable, right speaker light cable, and audio cable to the respective system board connectors.
4. Slide the ExpressCard cable into the connector and pull down the connector latches at both ends of the ExpressCard cable to secure the cable to the connectors.
5. Replace the magnesium cover (see "Replacing the Magnesium Cover" on page 51).
6. Replace the left and right brackets (see "Replacing the Brackets" on page 47).
7. Replace the palm rest (see "Replacing the Palm Rest" on page 44).
8. Replace the keyboard (see "Replacing the Keyboard" on page 39).
9. Replace the center control cover (see "Replacing the Center Control Cover" on page 35).
10. Replace the battery pack (see "Replacing the Battery Pack" on page 11).



CAUTION: Before turning on the computer, replace all screws and ensure that no stray screws remain inside the computer. Failure to do so may result in damage to the computer.

ህዳር ፳፭፣ ፳፻፲፭ ዓ.ም.

CHAPTER 15: OPTICAL DRIVE

Optical Drive



WARNING: Before working inside your computer, read the safety information that shipped with your computer. For additional safety best practices information, see the Regulatory Compliance Homepage at www.dell.com/regulatory_compliance.



CAUTION: To avoid electrostatic discharge, ground yourself by using a wrist grounding strap or by periodically touching an unpainted metal surface (such as a connector on the back of the computer).



CAUTION: Only a certified service technician should perform repairs on your computer. Damage due to servicing that is not authorized by Dell™ is not covered by your warranty.



CAUTION: To help prevent damage to the system board, remove the main battery (see "Removing the Battery Pack" on page 11) before working inside the computer.

Removing the Optical Drive

1. Follow the instructions in "Before You Begin" on page 6.
2. Remove the battery pack (see "Removing the Battery Pack" on page 11).
3. Remove the center control cover (see "Removing the Center Control Cover" on page 33).
4. Remove the keyboard (see "Removing the Keyboard" on page 38).
5. Remove the palm rest (see "Removing the Palm Rest" on page 42).
6. Remove the left and right brackets (see "Removing the Brackets" on page 47).
7. Remove the magnesium cover (see "Removing the Magnesium Cover" on page 50).
8. Remove the input/output board (see "Removing the Input/Output Board" on page 62).

- 9. Remove the two screws that secure the optical drive to the computer base.
- 10. Release the connector latch and disconnect the optical drive cable from the system board connector.

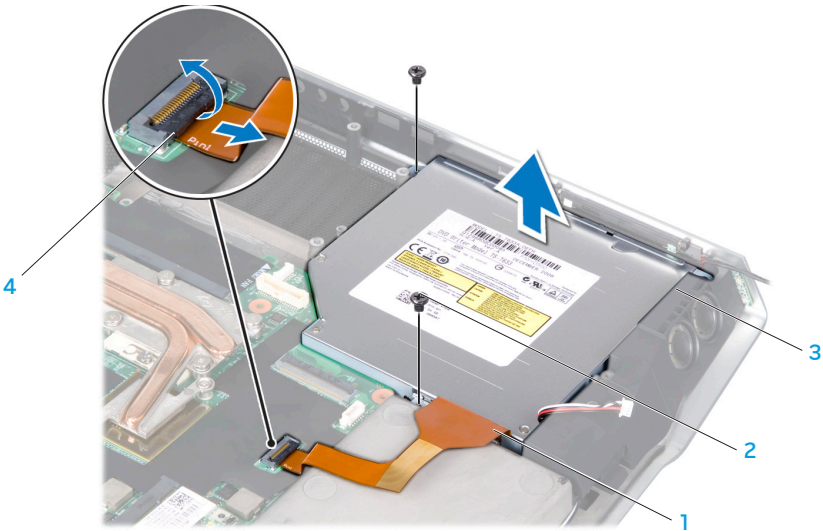

1 optical drive cable
2 screws (2)
3 optical drive
4 connector latch

- 11. Remove the five screws that secure the optical drive bracket to the optical drive.

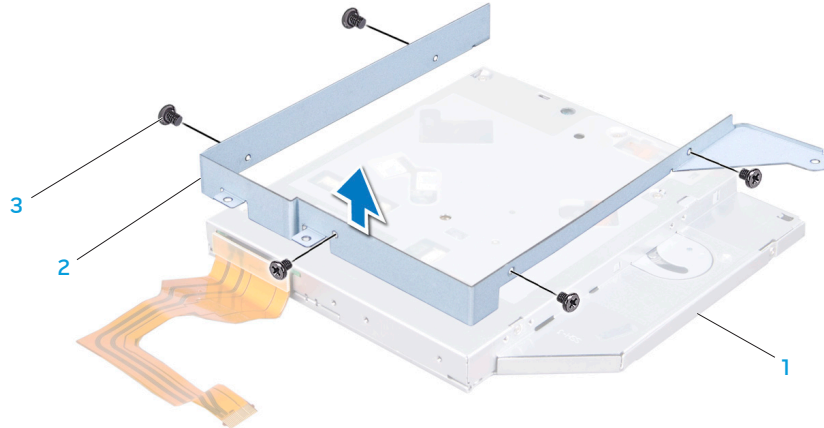

1 optical drive
2 optical drive bracket
3 screws (5)

- Disconnect the optical drive cable from the optical drive and remove the cable.

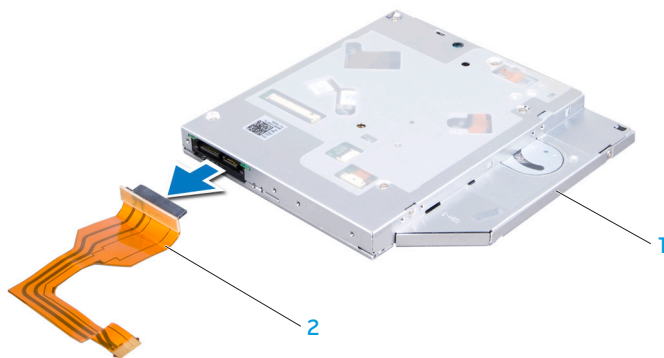

1 optical drive

2 optical drive cable

Replacing the Optical Drive

- Connect the optical drive cable to the optical drive.
- Replace the five screws that secure the optical drive bracket to the optical drive.
- Place the optical drive in the computer base.
- Slide the optical drive cable into the system board connector and pull down the connector latch to secure the cable to the connector.
- Replace the two screws that secure the optical drive to the computer base.
- Replace the input/output board (see “Replacing the Input/Output Board” on page 64).
- Replace the magnesium cover (see “Replacing the Magnesium Cover” on page 51).
- Replace the left and right brackets (see “Replacing the Brackets” on page 47).
- Replace the palm rest (see “Replacing the Palm Rest” on page 44).
- Replace the keyboard (see “Replacing the Keyboard” on page 39).
- Replace the center control cover (see “Replacing the Center Control Cover” on page 35).
- Replace the battery pack (see “Replacing the Battery Pack” on page 11).



CAUTION: Before turning on the computer, replace all screws and ensure that no stray screws remain inside the computer. Failure to do so may result in damage to the computer.

CHAPTER 16: WIRELESS MINI-CARD(S)

If you ordered a wireless Mini-Card with your computer, the card is already installed.

Your computer has two Mini-Card slots:

- one Full Mini-Card slot
- one Half Mini-Card slot

The types of Mini-Cards supported are:

- Wireless Local Area Network (WLAN) — Half Mini-Card
- Wireless Personal Area Network (WPAN) or Internal Card with Bluetooth® Wireless Technology — Full Mini-Card



NOTE: The WLAN slot supports a half Mini-Card.



NOTE: Depending on the configuration of the system when it was sold, one or more of the Mini-Card slots may not have Mini-Cards installed in them.

Wireless Mini-Card(s)



WARNING: Before working inside your computer, read the safety information that shipped with your computer. For additional safety best practices information, see the Regulatory Compliance Homepage at www.dell.com/regulatory_compliance.



CAUTION: To avoid electrostatic discharge, ground yourself by using a wrist grounding strap or by periodically touching an unpainted metal surface (such as a connector on the back of the computer).



CAUTION: Only a certified service technician should perform repairs on your computer. Damage due to servicing that is not authorized by Dell™ is not covered by your warranty.



CAUTION: To help prevent damage to the system board, remove the main battery (see "Removing the Battery Pack" on page 11) before working inside the computer.

Removing the Mini-Card(s)

1. Follow the instructions in “Before You Begin” on page 6.
2. Remove the battery pack (see “Removing the Battery Pack” on page 11).
3. Remove the palm rest (see “Removing the Palm Rest” on page 42).
4. Disconnect the antenna cables from the Mini-Card.
5. Pull back the securing clips to release the Mini-Cards.

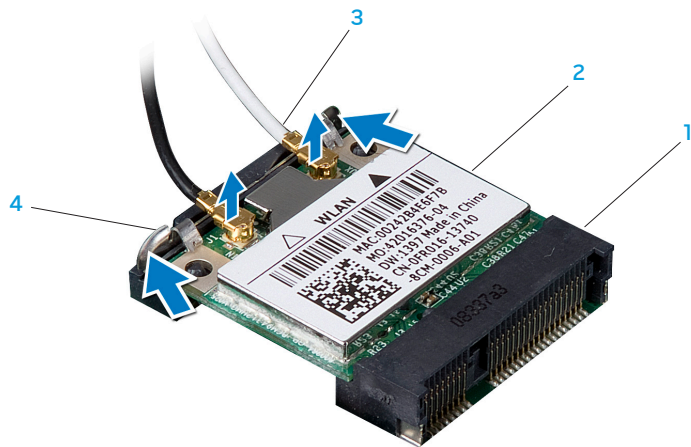

1 system board connector

2 WLAN Mini-Card

3 antenna cables (2 or 3)

4 clips (2)

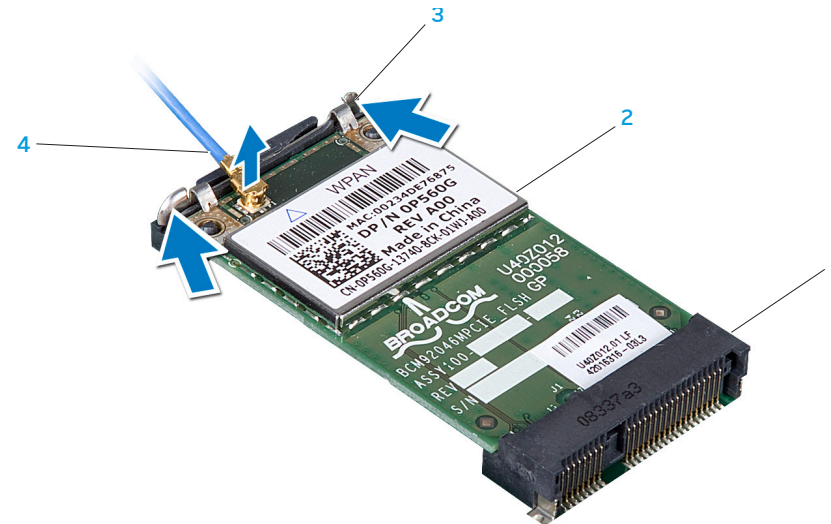

1 system board connector

2 WPAN/Bluetooth Mini-Card

3 clips (2)

4 antenna cable

6. Lift the Mini-Card at an angle and remove it from the system board connector.



CAUTION: When the Mini-Card is not in the computer, store it in protective antistatic packaging. For more information, see “Protecting Against Electrostatic Discharge” in the safety information that shipped with your computer.



1 system board connector

2 WLAN Mini-Card

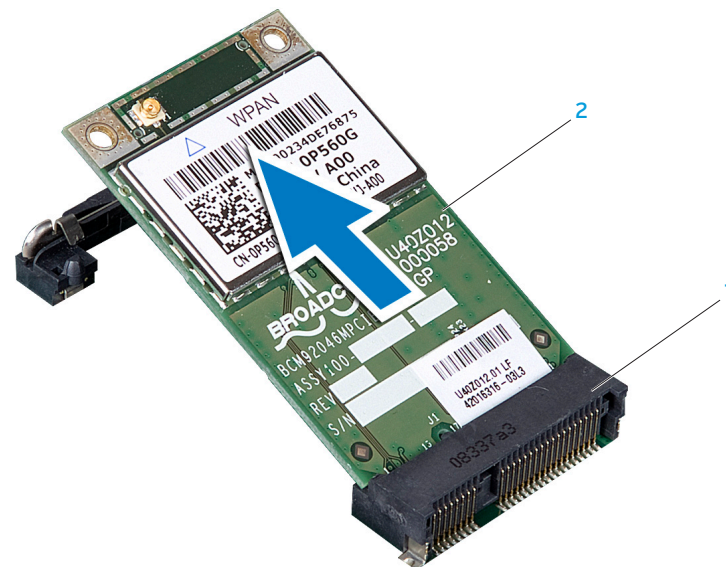

1 system board connector

2 WPAN/Bluetooth Mini-Card

Replacing the Mini-Card(s)

1. Remove the new Mini-Card from its packaging.



CAUTION: Use firm and even pressure to slide the card into place. If you use excessive force, you may damage the connector.

2. Insert the Mini-Card at a 45-degree angle into the appropriate system board connector. For example, the WLAN card connector is labeled WLAN and so on.
3. Press the other end of the Mini-Card down into the slot on the system board until it clicks into place.
4. Connect the appropriate antenna cables to the Mini-Card you are installing. The following table provides the antenna cable color scheme for the Mini-Card supported by your computer.

Connectors on the Mini-Card	Antenna Cable Color Scheme
WLAN (2 or 3 antenna cables):	
Main WLAN (white triangle)	white
Auxiliary WLAN (black triangle)	black
MIMO WLAN (gray triangle) (optional)	gray
WPAN (one antenna cable):	
WPAN	blue

6. Secure the unused antenna cables in the protective mylar sleeve.
7. Replace the palm rest (see “Replacing the Palm Rest” on page 44).
8. Replace the battery pack (see “Replacing the Battery Pack” on page 11).



CAUTION: Before turning on the computer, replace all screws and ensure that no stray screws remain inside the computer. Failure to do so may result in damage to the computer.

9. Install the drivers and utilities for your computer, as required.



NOTE: If you are installing a communication card from a source other than Dell or Alienware, you must install the appropriate drivers and utilities.

אנשי חינוך: חינוך ופיתוח

CHAPTER 17: PROCESSOR HEAT SINK

Processor Heat Sink



WARNING: Before working inside your computer, read the safety information that shipped with your computer. For additional safety best practices information, see the Regulatory Compliance Homepage at www.dell.com/regulatory_compliance.



CAUTION: To avoid electrostatic discharge, ground yourself by using a wrist grounding strap or by periodically touching an unpainted metal surface (such as a connector on the back of the computer).



CAUTION: Only a certified service technician should perform repairs on your computer. Damage due to servicing that is not authorized by Dell™ is not covered by your warranty.



CAUTION: To help prevent damage to the system board, remove the main battery (see "Removing the Battery Pack" on page 11) before working inside the computer.

Removing the Processor Heat Sink

1. Follow the instructions in “Before You Begin” on page 6.
2. Remove the battery pack (see “Removing the Battery Pack” on page 11).
3. Remove the center control cover (see “Removing the Center Control Cover” on page 33).
4. Remove the keyboard (see “Removing the Keyboard” on page 38).
5. Remove the palm rest (see “Removing the Palm Rest” on page 42).
6. Remove the left and right brackets (see “Removing the Brackets” on page 47).
7. Remove the magnesium cover (see “Removing the Magnesium Cover” on page 50).
8. Loosen the six captive screws that secure the processor heat sink to the system board.
9. Lift the processor heat sink off the system board.

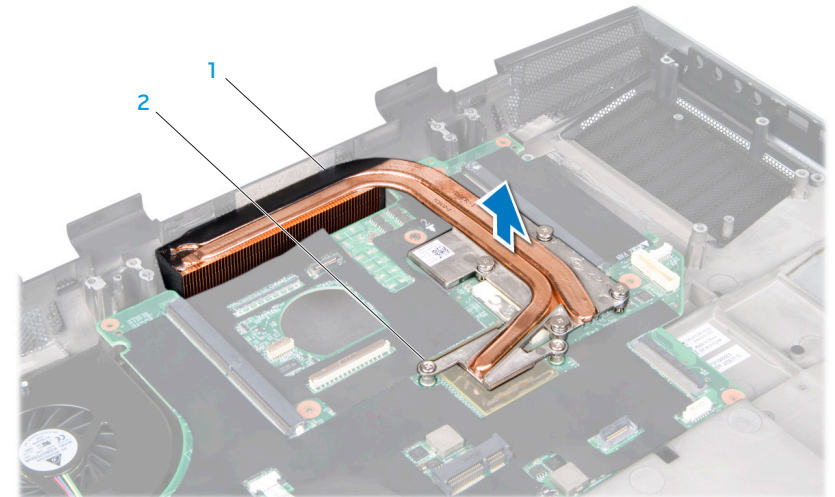

1 processor heat sink

2 captive screws (6)

Replacing the Processor Heat Sink

1. Peel the backing off the thermal cooling pads attached to the new processor heat sink.



NOTE: If the processor heat sink is replaced, the thermal cooling pads will be attached to the new processor heat sink. Do not reuse the old thermal cooling pads.

2. Place the processor heat sink on the system board.
3. Tighten the six captive screws that secure the processor heat sink to the system board.
4. Replace the magnesium cover (see “Replacing the Magnesium Cover” on page 51).
5. Replace the left and right brackets (see “Replacing the Brackets” on page 47).
6. Replace the palm rest (see “Replacing the Palm Rest” on page 44).
7. Replace the keyboard (see “Replacing the Keyboard” on page 39).
8. Replace the center control cover (see “Replacing the Center Control Cover” on page 35).
9. Replace the battery pack (see “Replacing the Battery Pack” on page 11).



CAUTION: Before turning on the computer, replace all screws and ensure that no stray screws remain inside the computer. Failure to do so may result in damage to the computer.



CHAPTER 18: GRAPHICS CARD(S)

Your computer may have a single graphics or dual graphics configuration. The graphics card on the left is the primary graphics card and the graphics card on the right is the secondary graphics card.

In a single graphics configuration, your computer will only have a primary graphics card.

In a dual graphics configuration, your computer will have a primary graphics card, a secondary graphics card, and a graphics cable connecting the primary and secondary graphics cards.

Graphics Card(s)



WARNING: Before working inside your computer, read the safety information that shipped with your computer. For additional safety best practices information, see the Regulatory Compliance Homepage at www.dell.com/regulatory_compliance.



CAUTION: To avoid electrostatic discharge, ground yourself by using a wrist grounding strap or by periodically touching an unpainted metal surface (such as a connector on the back of the computer).



CAUTION: Only a certified service technician should perform repairs on your computer. Damage due to servicing that is not authorized by Dell™ is not covered by your warranty.



CAUTION: To help prevent damage to the system board, remove the main battery (see "Removing the Battery Pack" on page 11) before working inside the computer.

Removing the Graphics Card(s)

1. Follow the instructions in “Before You Begin” on page 6.
2. Remove the battery pack (see “Removing the Battery Pack” on page 11).
3. Remove the center control cover (see “Removing the Center Control Cover” on page 33).
4. Remove the keyboard (see “Removing the Keyboard” on page 38).
5. To remove the secondary graphics card, if applicable:
 - a. Remove the right bracket (see “Removing the Brackets” on page 47).
 - b. Disconnect the graphics card cable from the connector on the primary graphics card.
 - c. Remove the two screws that secure the secondary graphics card to the system board.
 - d. Lift the secondary graphics card at an angle and remove it from the system board connector.

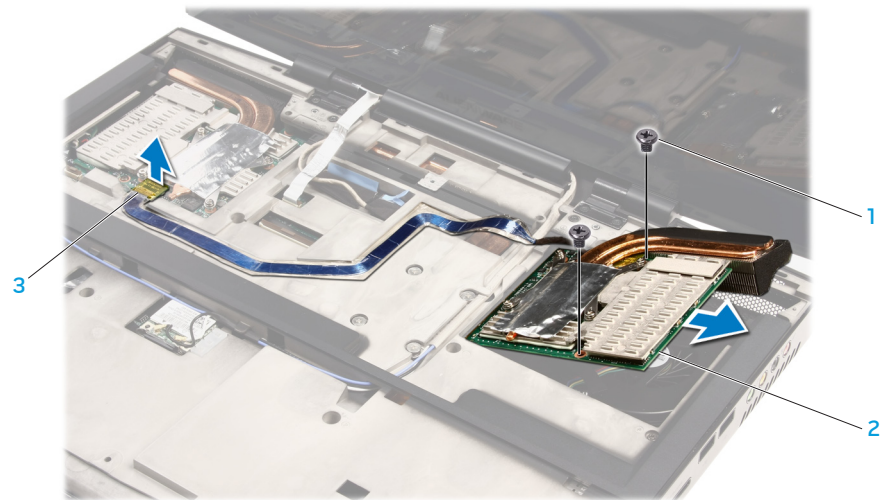

1 screws (2)

2 secondary graphics card

3 graphics card cable connector

6. To remove the primary graphics card:
 - a. Remove the left bracket (see “Removing the Brackets” on page 47).
 - b. Remove the two screws that secure the primary graphics card to the system board.
 - c. Lift the primary graphics card at an angle and remove it from the system board connector.

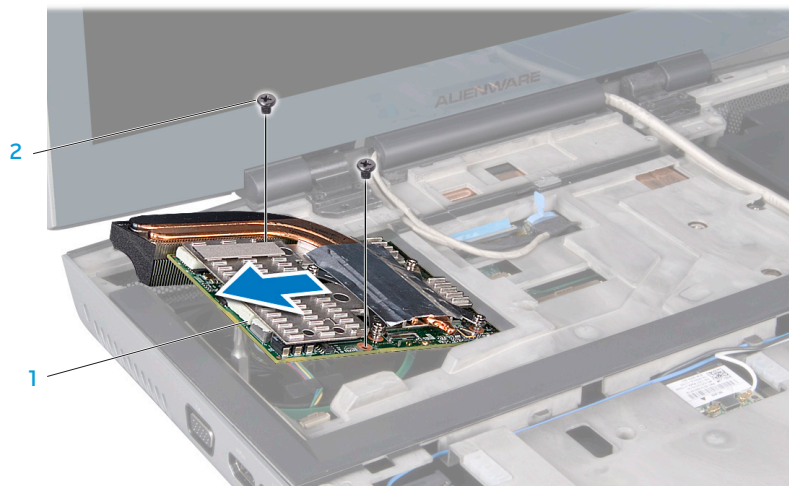

1 primary graphics card

2 screws (2)

Replacing the Graphics Card(s)

1. To replace the primary graphics card:
 - a. Insert the primary graphics card at a 45-degree angle into the system board connector.
 - b. Replace the two screws that secure the primary graphics card to the system board.
 - c. Replace the left bracket (see “Replacing the Brackets” on page 47).
2. To replace the secondary graphics card, if applicable:
 - a. Insert the secondary graphics card at a 45-degree angle into the system board connector.
 - b. Replace the two screws that secure the secondary graphics card to the system board.
 - c. Connect the graphics cable to the connector on the primary graphics card.
 - d. Replace the right bracket (see “Replacing the Brackets” on page 47).
3. Replace the keyboard (see “Replacing the Keyboard” on page 39).
4. Replace the center control cover (see “Replacing the Center Control Cover” on page 35).
5. Replace the battery pack (see “Replacing the Battery Pack” on page 11).



CAUTION: Before turning on the computer, replace all screws and ensure that no stray screws remain inside the computer. Failure to do so may result in damage to the computer.



CHAPTER 19: GRAPHICS CARD FAN(S)

Your computer may have a single graphics or dual graphics configuration. The graphics card on the left is the primary graphics card and the graphics card on the right is the secondary graphics card. The primary graphics card will have a primary graphics card fan and the secondary graphics card will have a secondary graphics card fan.

Graphics Card Fan(s)



WARNING: Before working inside your computer, read the safety information that shipped with your computer. For additional safety best practices information, see the Regulatory Compliance Homepage at www.dell.com/regulatory_compliance.



CAUTION: To avoid electrostatic discharge, ground yourself by using a wrist grounding strap or by periodically touching an unpainted metal surface (such as a connector on the back of the computer).



CAUTION: Only a certified service technician should perform repairs on your computer. Damage due to servicing that is not authorized by Dell™ is not covered by your warranty.



CAUTION: To help prevent damage to the system board, remove the main battery (see "Removing the Battery Pack" on page 11) before working inside the computer.

Removing the Graphics Card Fan(s)

1. Follow the instructions in “Before You Begin” on page 6.
2. Remove the battery pack (see “Removing the Battery Pack” on page 11).
3. Remove the center control cover (see “Removing the Center Control Cover” on page 33).
4. Remove the keyboard (see “Removing the Keyboard” on page 38).
5. Remove the left bracket (see “Removing the Brackets” on page 47).
6. Remove the primary graphics card (see “Removing the Graphics Card(s)” on page 80).
7. Remove the right bracket, if applicable (see “Removing the Brackets” on page 47).



NOTE: If your computer has two graphics cards, then your computer will have two graphics card fans.

8. Remove the secondary graphics card, if applicable (see “Removing the Graphics Card(s)” on page 80).
9. Loosen the three captive screws that secure the graphics card fan to the computer base.
10. Disconnect the graphics card fan cable from the system board connector.
11. Lift the graphics card fan off the computer base.

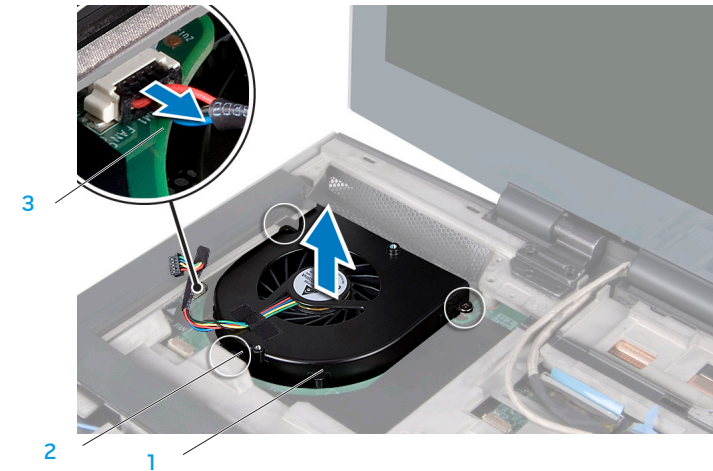

1 primary graphics card fan

2 captive screws (3)

3 primary graphics card fan cable

Replacing the Graphics Card Fan(s)

1. Place the graphics card fan in the computer base.
2. Tighten the three captive screws that secure the graphics card fan to the computer base.
3. Connect the graphics card fan cable to the system board connector.
4. Replace the primary graphics card (see “Replacing the Graphics Card(s)” on page 81).
5. Replace the left bracket (see “Replacing the Brackets” on page 47).
6. Replace the secondary graphics card, if applicable (see “Replacing the Graphics Card(s)” on page 81).
7. Replace the right bracket, if applicable (see “Replacing the Brackets” on page 47).
8. Replace the keyboard (see “Replacing the Keyboard” on page 39).
9. Replace the center control cover (see “Replacing the Center Control Cover” on page 35).
10. Replace the battery pack (see “Replacing the Battery Pack” on page 11).



CAUTION: Before turning on the computer, replace all screws and ensure that no stray screws remain inside the computer. Failure to do so may result in damage to the computer.

ህዳር ፳፻፲፱ ዓ.ም. ለግብርና ስራ ለውጤት ለማረጋገጥ

CHAPTER 20: GRAPHICS CARD BLANK

If your computer has a dual graphics configuration, the secondary graphics card is already installed on the right side of the computer base (to remove and replace the graphics card see the instructions in “Graphics Card(s) on page 78” and “Graphics Card Fan(s) on page 82).

If you do not have a secondary graphics card, your computer will have a graphics card blank instead.

Graphics Card Blank



WARNING: Before working inside your computer, read the safety information that shipped with your computer. For additional safety best practices information, see the Regulatory Compliance Homepage at www.dell.com/regulatory_compliance.



CAUTION: To avoid electrostatic discharge, ground yourself by using a wrist grounding strap or by periodically touching an unpainted metal surface (such as a connector on the back of the computer).



CAUTION: Only a certified service technician should perform repairs on your computer. Damage due to servicing that is not authorized by Dell™ is not covered by your warranty.



CAUTION: To help prevent damage to the system board, remove the main battery (see "Removing the Battery Pack" on page 11) before working inside the computer.

Removing the Graphics Card Blank

1. Follow the instructions in “Before You Begin” on page 6.
2. Remove the battery pack (see “Removing the Battery Pack” on page 11).
3. Remove the center control cover (see “Removing the Center Control Cover” on page 33).
4. Remove the keyboard (see “Removing the Keyboard” on page 38).
5. Remove the right bracket (see “Removing the Brackets” on page 47).
6. Loosen the three captive screws that secure the graphics card blank to the computer base.
7. Lift the graphics card blank off the computer base.

Replacing the Graphics Card Blank

1. Place the graphics card blank in the computer base.
2. Tighten the three captive screws that secure the graphics card blank to the computer base.
3. Replace the right bracket (see “Replacing the Brackets” on page 47).
4. Replace the keyboard (see “Replacing the Keyboard” on page 39).
5. Replace the center control cover (see “Replacing the Center Control Cover” on page 35).
6. Replace the battery pack (see “Replacing the Battery Pack” on page 11).



CAUTION: Before turning on the computer, replace all screws and ensure that no stray screws remain inside the computer. Failure to do so may result in damage to the computer.

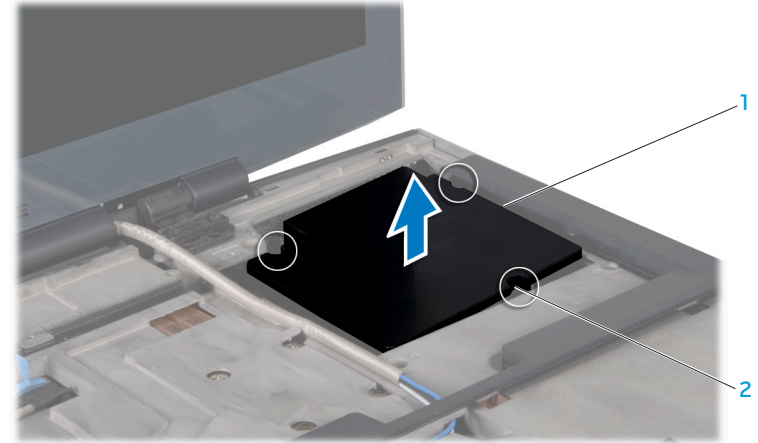

1 graphics card blank

2 captive screws (3)



CHAPTER 21: SYSTEM BOARD

The system board's BIOS chip contains the Service Tag, which is also visible on a barcode label on the bottom of the computer. The replacement kit for the system board includes a CD that provides a utility for transferring the Service Tag to the replacement system board.

System Board



WARNING: Before working inside your computer, read the safety information that shipped with your computer. For additional safety best practices information, see the Regulatory Compliance Homepage at www.dell.com/regulatory_compliance.



CAUTION: To avoid electrostatic discharge, ground yourself by using a wrist grounding strap or by periodically touching an unpainted metal surface (such as a connector on the back of the computer).



CAUTION: Only a certified service technician should perform repairs on your computer. Damage due to servicing that is not authorized by Dell™ is not covered by your warranty.



CAUTION: To help prevent damage to the system board, remove the main battery (see “Removing the Battery Pack” on page 11) before working inside the computer.



CAUTION: Handle components and cards by their edges, and avoid touching pins and contacts.

Removing the System Board

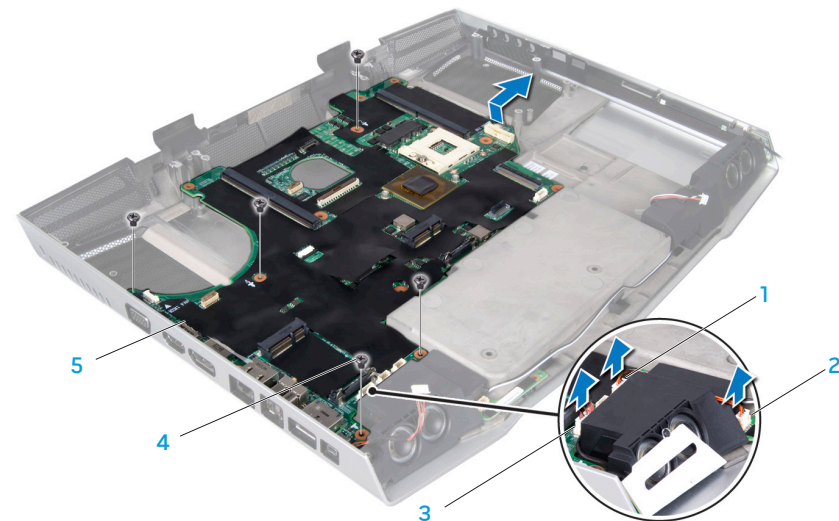

1. Follow the instructions in “Before You Begin” on page 6.
2. Remove the battery pack (see “Removing the Battery Pack” on page 11).
3. Remove the compartment door (see “Removing the Compartment Door” on page 14).
4. Remove the hard drive(s) (see “Removing the Hard Drive(s)” on page 17).
5. Disconnect the processor thermal fan cable from the system board connector (see “Removing the Processor Thermal Fan” on page 22).
6. Disconnect the coin-cell battery cable from the system board connector (see “Removing the Coin-Cell Battery” on page 25).
7. Remove the memory module(s) (see “Removing the Memory Module(s)” on page 28).
8. Remove the palm rest (see “Removing the Palm Rest” on page 42).
9. Remove the center control cover (see “Removing the Center Control Cover” on page 33).
10. Remove the keyboard (see “Removing the Keyboard” on page 38).
11. Remove the left and right brackets (see “Removing the Brackets” on page 47).
12. Remove the magnesium cover (see “Removing the Magnesium Cover” on page 50).

13. Remove the input/output board (see “Removing the Input/Output Board” on page 62).
14. Remove the optical drive (see “Removing the Optical Drive” on page 66).
15. Remove the Mini-Card(s) (see “Removing the Mini-Card(s)” on page 71).
16. Remove the processor heat sink (see “Removing the Processor Heat Sink” on page 76).
17. Remove the graphics card(s) (see “Removing the Graphics Card(s)” on page 80).
18. Disconnect the graphics card fan(s) cable from the system board connector (see “Removing the Graphics Card Fan(s)” on page 84).
19. Remove the graphics card blank, if applicable (see “Removing the Graphics Card Blank” on page 88).
20. Remove the five screws that secure the system board to the computer base.
21. Disconnect the consumer IR cable from the connectors on the system board and consumer IR board.
22. Disconnect the left speaker light cable from the system board connector.
23. Lift the system board at an angle and remove it from the computer base.



- | | | | |
|---|--|---|--------------|
| 1 | consumer IR cable connector on system board | 4 | screws (5) |
| 2 | consumer IR cable connector on consumer IR board | 5 | system board |
| 3 | left speaker light cable connector | | |

Replacing the System Board

1. Insert the system board at an angle into the computer base.
 2. Connect the consumer IR cable to the connectors on the system board and the consumer IR board.
 3. Connect the left speaker light cable to the system board connector.
 4. Replace the five screws that secure the system board to the computer base.
 5. Replace the graphics card blank, if applicable (see “Replacing the Graphics Card Blank” on page 88).
 6. Connect the graphics card fan(s) cable to the system board connector (see “Replacing the Graphics Card Fan(s)” on page 85).
 7. Replace the graphics card(s) (see “Replacing the Graphics Card(s)” on page 81).
 8. Replace the processor heat sink (see “Replacing the Processor Heat Sink” on page 77).
 9. Replace the Mini-Card(s) (see “Replacing the Mini-Card(s)” on page 73).
 10. Replace the optical drive (see “Replacing the Optical Drive” on page 68).
 11. Replace the input/output board (see “Replacing the Input/Output Board” on page 64).
 12. Replace the magnesium cover (see “Replacing the Magnesium Cover” on page 51).
 13. Replace the left and right brackets (see “Replacing the Brackets” on page 47).
 14. Replace the keyboard (see “Replacing the Keyboard” on page 39).
 15. Replace the center control cover (see “Replacing the Center Control Cover” on page 35).
 16. Replace the palm rest (see “Replacing the Palm Rest” on page 44).
 17. Replace the memory module(s) (see “Replacing the Memory Module(s)” on page 29).
 18. Connect the coin-cell battery cable to the system board connector (see “Replacing the Coin-Cell Battery” on page 25).
 19. Connect the processor thermal fan cable to the system board connector (see “Replacing the Processor Thermal Fan” on page 22).
 20. Replace the hard drive(s) (see “Replacing the Hard Drive(s)” on page 19).
 21. Replace the compartment door (see “Replacing the Compartment Door” on page 14).
 22. Replace the battery pack (see “Replacing the Battery Pack” on page 11).
-  **CAUTION:** Before turning on the computer, replace all screws and ensure that no stray screws remain inside the computer. Failure to do so may result in damage to the computer.
23. Turn on the computer.
-  **NOTE:** After you have replaced the system board, enter the computer Service Tag into the BIOS of the replacement system board.
24. Insert the BIOS upgrade CD that accompanied the replacement system board into the appropriate drive. Follow the instructions that appear on the screen.

ገጽ ፳፯ ለገጽ ፳፰

CHAPTER 22: SPEAKERS

Speakers



WARNING: Before working inside your computer, read the safety information that shipped with your computer. For additional safety best practices information, see the Regulatory Compliance Homepage at www.dell.com/regulatory_compliance.



CAUTION: To avoid electrostatic discharge, ground yourself by using a wrist grounding strap or by periodically touching an unpainted metal surface (such as a connector on the back of the computer).



CAUTION: Only a certified service technician should perform repairs on your computer. Damage due to servicing that is not authorized by Dell™ is not covered by your warranty.



CAUTION: To help prevent damage to the system board, remove the main battery (see "Removing the Battery Pack" on page 11) before working inside the computer.

Removing the Speakers

1. Follow the instructions in “Before You Begin” on page 6.
2. Remove the system board (see “Removing the System Board” on page 90).
3. Remove the speaker cables from the routing guides.
4. Lift the speakers off the computer base.

Replacing the Speakers

1. Place the speakers on the computer base.
2. Route the speaker cables into the routing guides.
3. Replace the system board (see “Replacing the System Board” on page 92).



CAUTION: Before turning on the computer, replace all screws and ensure that no stray screws remain inside the computer. Failure to do so may result in damage to the computer.

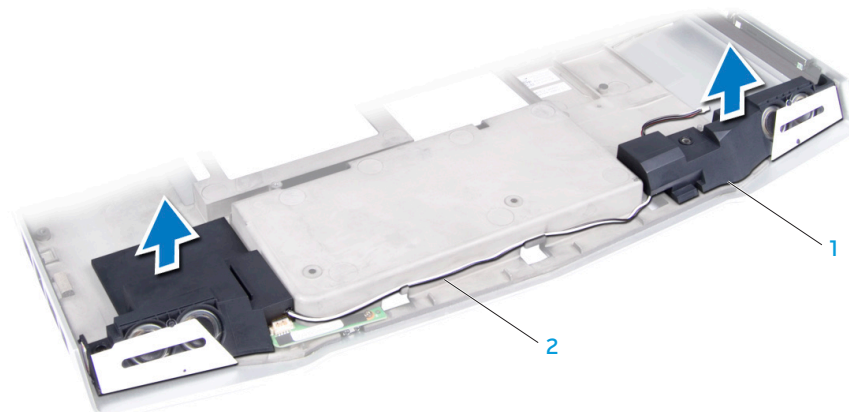

1 speakers (2)

2 speaker cables

אגודת הצרכנים: אגודת הצרכנים בישראל

CHAPTER 23: CONSUMER IR BOARD

Consumer IR Board



WARNING: Before working inside your computer, read the safety information that shipped with your computer. For additional safety best practices information, see the Regulatory Compliance Homepage at www.dell.com/regulatory_compliance.



CAUTION: To avoid electrostatic discharge, ground yourself by using a wrist grounding strap or by periodically touching an unpainted metal surface (such as a connector on the back of the computer).



CAUTION: Only a certified service technician should perform repairs on your computer. Damage due to servicing that is not authorized by Dell™ is not covered by your warranty.



CAUTION: To help prevent damage to the system board, remove the main battery (see "Removing the Battery Pack" on page 11) before working inside the computer.

Removing the Consumer IR Board

1. Follow the instructions in “Before You Begin” on page 6.
2. Remove the system board (see “Removing the System Board” on page 90).
3. Remove the speakers (see “Removing the Speakers” on page 95).
4. Remove the two screws that secure the consumer IR board to the computer base.
5. Lift the consumer IR board off the computer base.

Replacing the Consumer IR Board

1. Place the consumer IR board on the computer base.
2. Replace the two screws that secure the consumer IR board to the computer base.
3. Replace the speakers (see “Replacing the Speakers” on page 95).
4. Replace the system board (see “Replacing the System Board” on page 92).



CAUTION: Before turning on the computer, replace all screws and ensure that no stray screws remain inside the computer. Failure to do so may result in damage to the computer.

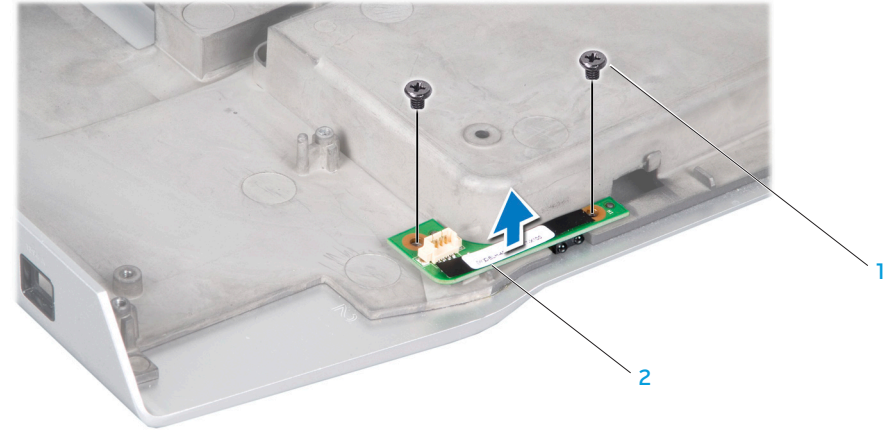

1 screws (2)

2 consumer IR board

ህዝብ ለግንባታው ለሚገቡት ገንዘብ ለማግኘት ሚስቱን ለማሸነፍ ሲሞክር

CHAPTER 24: BATTERY LATCH ASSEMBLY

Battery Latch Assembly



WARNING: Before working inside your computer, read the safety information that shipped with your computer. For additional safety best practices information, see the Regulatory Compliance Homepage at www.dell.com/regulatory_compliance.



CAUTION: To avoid electrostatic discharge, ground yourself by using a wrist grounding strap or by periodically touching an unpainted metal surface (such as a connector on the back of the computer).



CAUTION: Only a certified service technician should perform repairs on your computer. Damage due to servicing that is not authorized by Dell™ is not covered by your warranty.



CAUTION: To help prevent damage to the system board, remove the main battery (see "Removing the Battery Pack" on page 11) before working inside the computer.

Removing the Battery Latch Assembly

1. Follow the instructions in “Before You Begin” on page 6.
2. Remove the system board (see “Removing the System Board” on page 90).
3. Press and push the plastic clip on the battery release latch to release it from the battery latch assembly.
4. Using a screwdriver, remove the latch spring from the hook on the battery latch assembly.
5. Lift the battery latch assembly out of the computer base.

Replacing the Battery Latch Assembly

1. Push the plastic clips on the battery release latch into the hole on the battery latch assembly to secure the battery release latch.
2. Place the battery latch assembly in the channel in the computer base.
3. Using a screwdriver, place the spring over the hook on the computer base. Ensure that the newly installed latch moves smoothly and freely when pushed and released.
4. Replace the system board (see “Replacing the System Board” on page 92).



CAUTION: Before turning on the computer, replace all screws and ensure that no stray screws remain inside the computer. Failure to do so may result in damage to the computer.

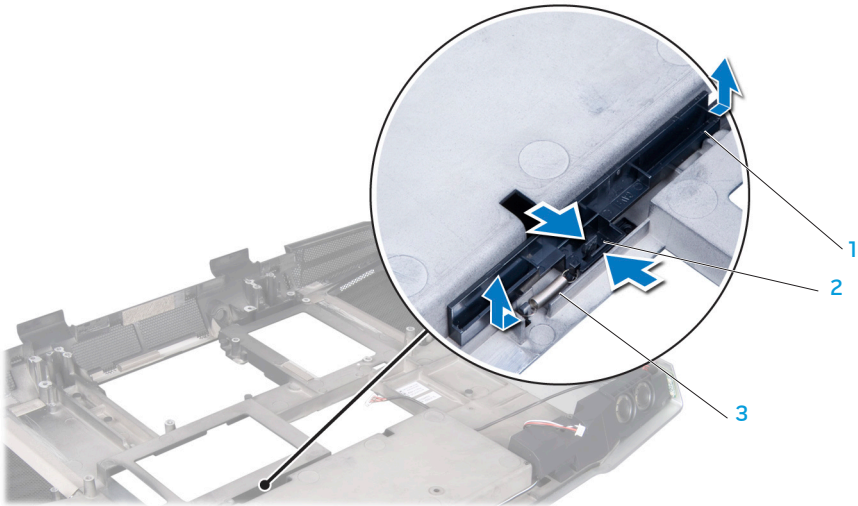

1 battery latch assembly

2 clip

3 spring

~\XVCXVI ☺: 77.EVDXAC/ XW XAEJ

CHAPTER 25: FLASHING THE BIOS

Flashing the BIOS



WARNING: Before working inside your computer, read the safety information that shipped with your computer. For additional safety best practices information, see the Regulatory Compliance Homepage at www.dell.com/regulatory_compliance.



CAUTION: To avoid electrostatic discharge, ground yourself by using a wrist grounding strap or by periodically touching an unpainted metal surface (such as a connector on the back of the computer).



CAUTION: Only a certified service technician should perform repairs on your computer. Damage due to servicing that is not authorized by Dell™ is not covered by your warranty.



CAUTION: To help prevent damage to the system board, remove the main battery (see “Removing the Battery Pack” on page 11) before working inside the computer.

If a BIOS upgrade CD is provided with the new system board, flash the BIOS from the CD. If you do not have a BIOS upgrade CD, flash the BIOS from the hard drive.

Flashing the BIOS from a CD

1. Ensure that the AC adapter is plugged in and that the main battery is installed properly.



NOTE: If you use a BIOS upgrade CD to flash the BIOS, set up the computer to boot from a CD before inserting the CD.

2. Insert the BIOS upgrade CD, and restart the computer. Follow the instructions that appear on the screen. The computer continues to boot and updates the new BIOS. When the flash update is complete, the computer will automatically reboot.
3. Press <F2> during POST to enter the system setup program.
4. Select the **Exit** menu.
5. Select **Load Setup Defaults** to reset the computer defaults.
6. Remove the BIOS upgrade CD from the drive.
7. Select **Exit Saving Changes** to save configuration changes.
8. The BIOS upgrade finishes and the computer restarts automatically.

Flashing the BIOS from the Hard Drive

1. Ensure that the AC adapter is plugged in, the main battery is properly installed, and a network cable is attached.
2. Turn on the computer.
3. Locate the latest BIOS update file for your computer at **support.dell.com**.
4. Click **Drivers & Downloads** → **Select Model**.
5. Select the type of product in the **Select Your Product Family** list.
6. Select the product brand in the **Select Your Product Line** list.
7. Select the product model number in the **Select Your Product Model** list.



NOTE: If you have selected a different model and want to start over again, click **Start Over** on the top right of the menu.

8. Click **Confirm**.
A list of results appear on the screen.
9. Click **BIOS**.
10. Click **Download Now** to download the latest BIOS file.
The **File Download** window appears.
11. Click **Save** to save the file to your desktop.
The file downloads to your desktop.
12. Click **Close** if the **Download Complete** window appears.
The file icon appears on your desktop and is titled the same as the downloaded BIOS update file.
13. Double-click the file icon on the desktop and follow the instructions on the screen.